

SPECIFICATIONS

MAX VOLTAGE - 600VAC 3 ϕ
 RATED CURRENT - 400 A
 STANDARDS - UL508A
 ENCLOSURE RATING - NEMA 3R
 REF. ES100145SE
 DURABILITY - 6050 CYCLES
 COLOR - RAL7035 LIGHT COLOR
 EST SHIPPING WEIGHT - 450LBS

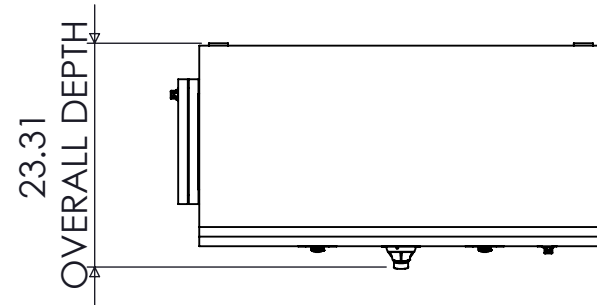

TOP VIEW

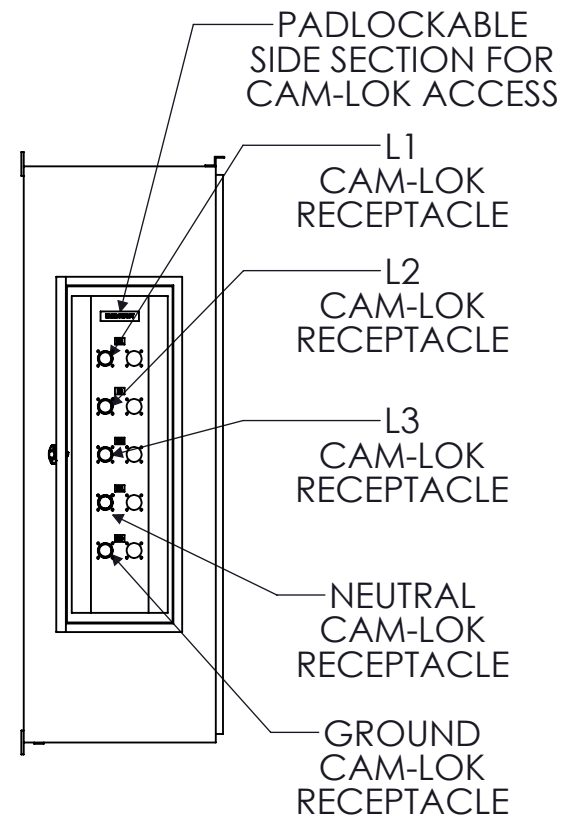

SIDE VIEW

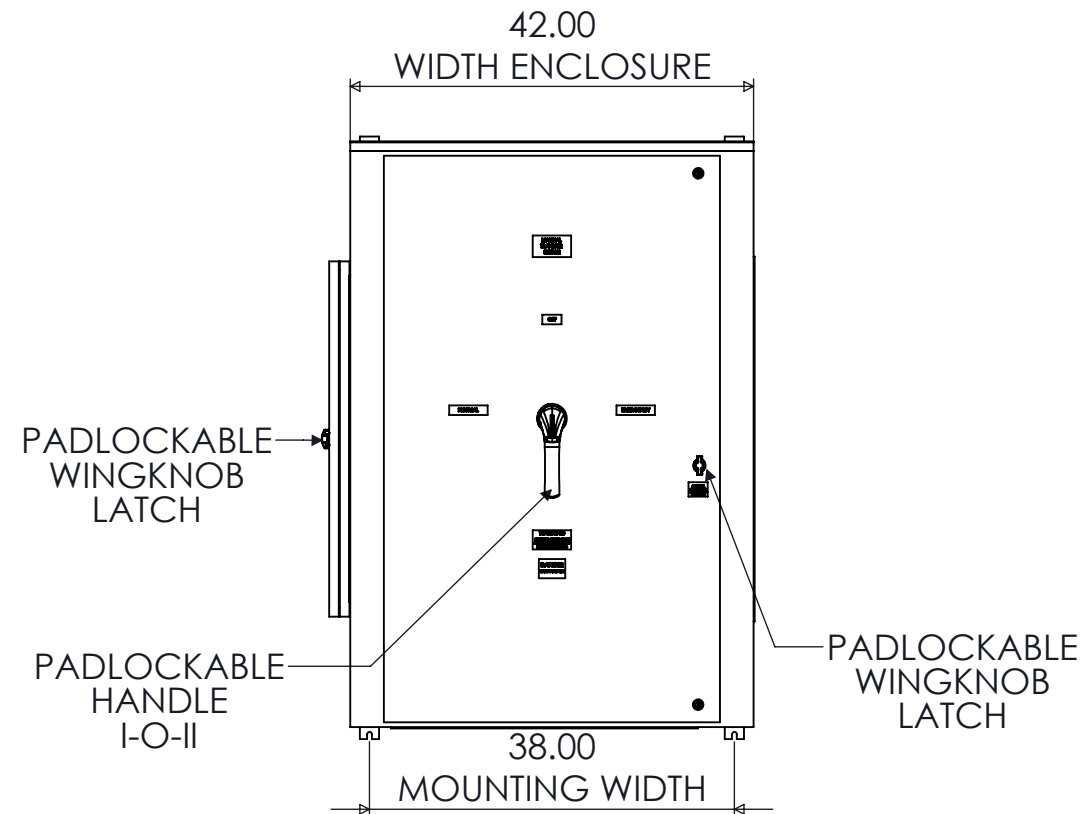

FRONT VIEW

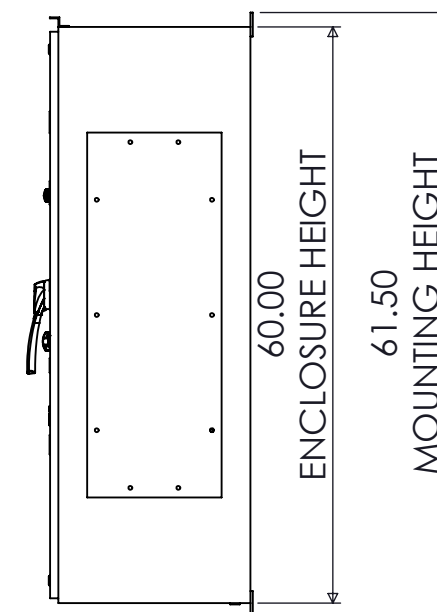

SIDE VIEW

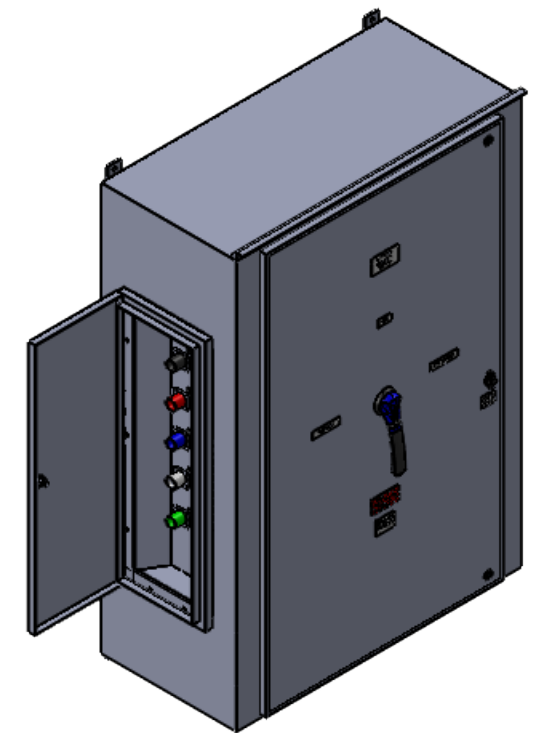

DIMETRIC VIEW

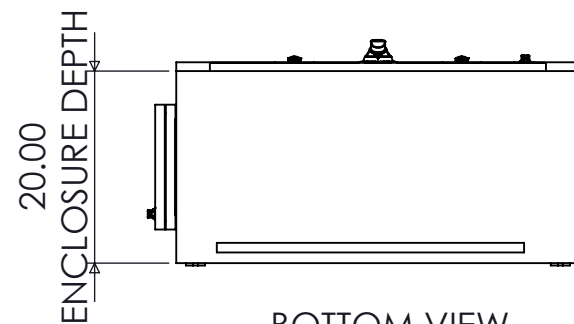

BOTTOM VIEW

RECEPTACLE/COVER COLOR SCHEME

	L1	L2	L3	N	GND
240VAC	BLK	RED	BLU	WHT	GRN
480VAC	BRN	ORG	YEL	WHT	GRN
600VAC	BLK	BLK	BLK	WHT	GRN

400A SE-RATED 3-POLE NEMA 3R MANUAL TRANSFER SWITCH WITH CAM-LOKS (LEFT)

REV	DESCRIPTION	DATE	DRAWN	JG
0	ORIGINAL RELEASE	1/22/18	CHECKED	
			SUP. NO	
			SUP. BY NO	
			PANEL NO	
			BUIL. NO	
			GROUP NO	
			ORDER NO	

DRAWING TYPE
DIMENSIONAL

DRAWING NUMBER
STS400N3RSE3CL



9900 TWIN LAKES PARKWAY
 CHARLOTTE, NC 28269
 704-596-5617
 PSICONTROLSOLUTIONS.COM

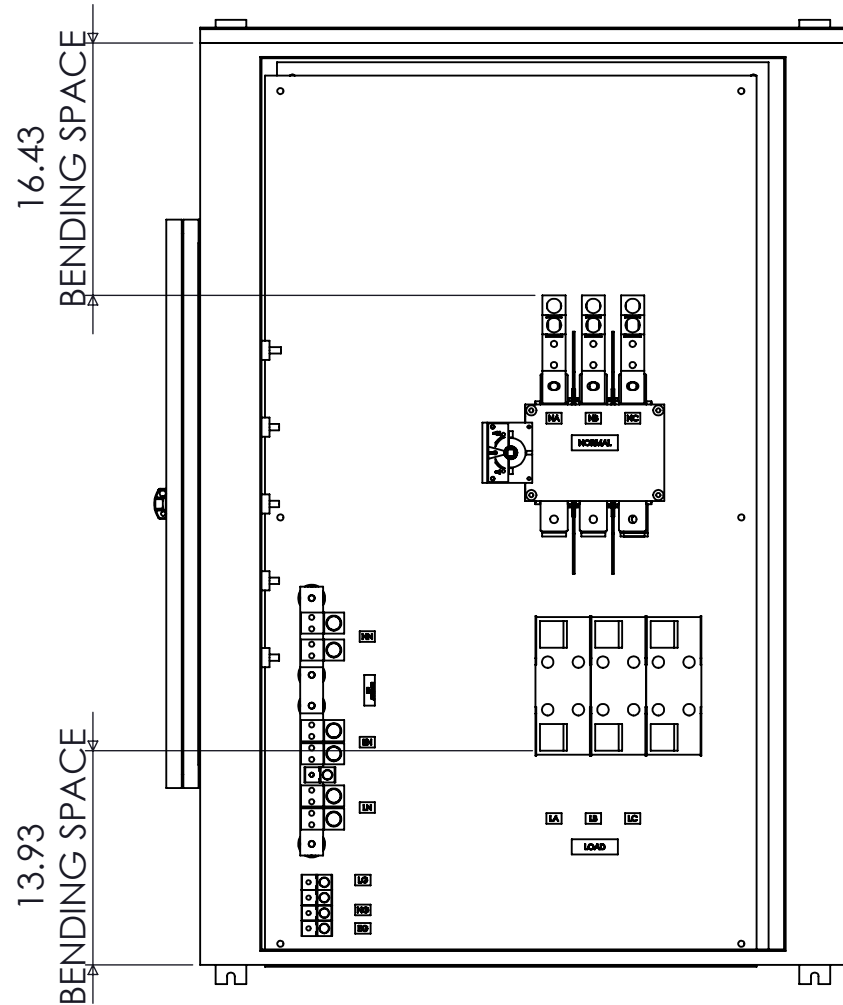

FRONT VIEW
DOOR REMOVED

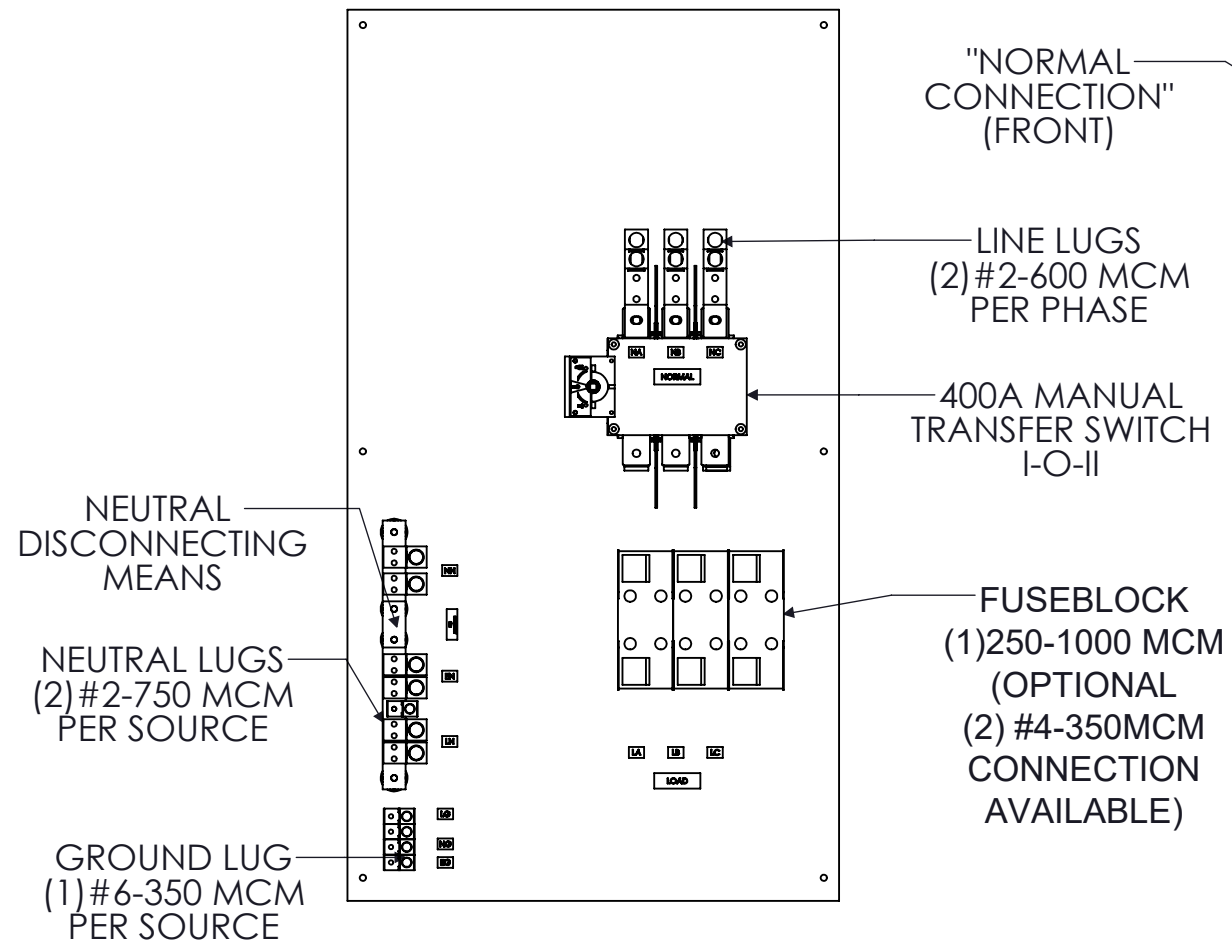

FRONT VIEW
ENCLOSURE REMOVED

"EMERGENCY
CONNECTION"
(CAM-LOKS)

"NORMAL
CONNECTION"
(FRONT)

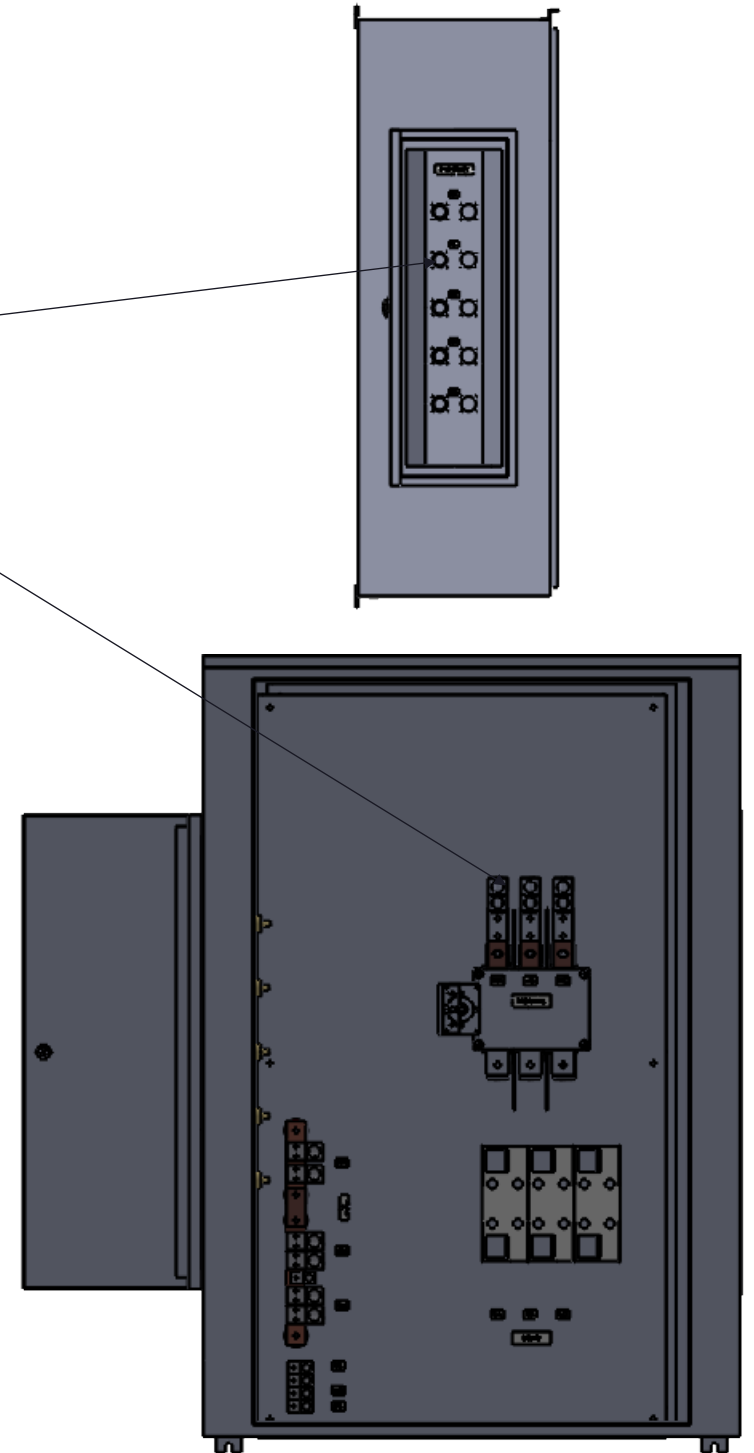

FRONT VIEW
DOOR REMOVED

NOTE: FUSES PROVIDED IF PURCHASED
208-240VAC : FRN-R-400
480-600VAC : LPJ-400SP

 9900 TWIN LAKES PARKWAY
CHARLOTTE, NC 28269
704-596-5617
PSICONTROLSOLUTIONS.COM

400A SE-RATED 3-POLE NEMA 3R MANUAL TRANSFER SWITCH WITH CAM-LOKS (LEFT)			
REV	DESCRIPTION	DATE	DRAWN JG
0	ORIGINAL RELEASE	1/22/18	CHECKED
			SUP. NO
			SUP. BY NO
			PANEL NO
			BUL. NO
			GROUP NO
			ORDER NO

DRAWING TYPE	OUTLINE
DRAWING NUMBER	STS400N3RSE3CL