

TOP VIEW

23.31
OVERALL DEPTH

SPECIFICATIONS

MAX VOLTAGE - 600VAC 3 ϕ
 RATED CURRENT - 400 A
 STANDARDS - UL508A
 ENCLOSURE RATING - NEMA 3R
 REF. ES100145NF
 DURABILITY - 6050 CYCLES
 COLOR - RAL7035 LIGHT COLOR
 EST SHIPPING WEIGHT - 425LBS

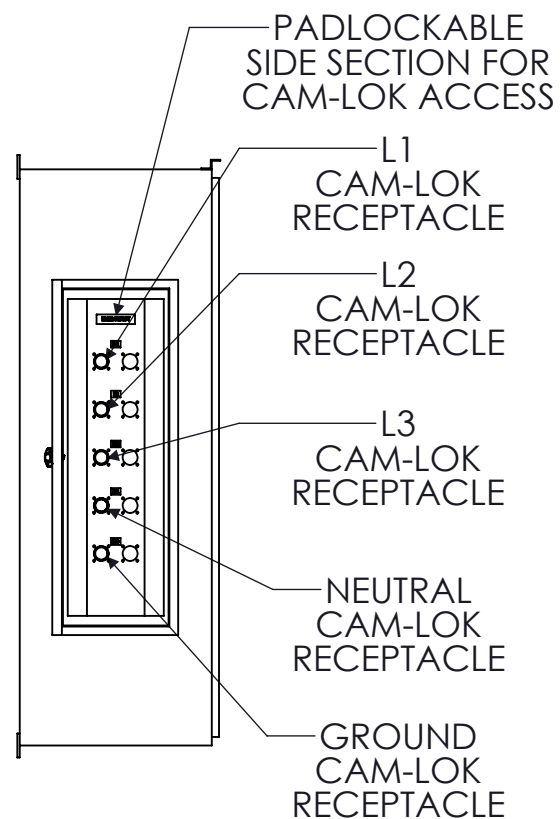

SIDE VIEW

PADLOCKABLE
SIDE SECTION FOR
CAM-LOK ACCESS

L1
CAM-LOK
RECEPTACLE

L2
CAM-LOK
RECEPTACLE

L3
CAM-LOK
RECEPTACLE

NEUTRAL
CAM-LOK
RECEPTACLE

GROUND
CAM-LOK
RECEPTACLE

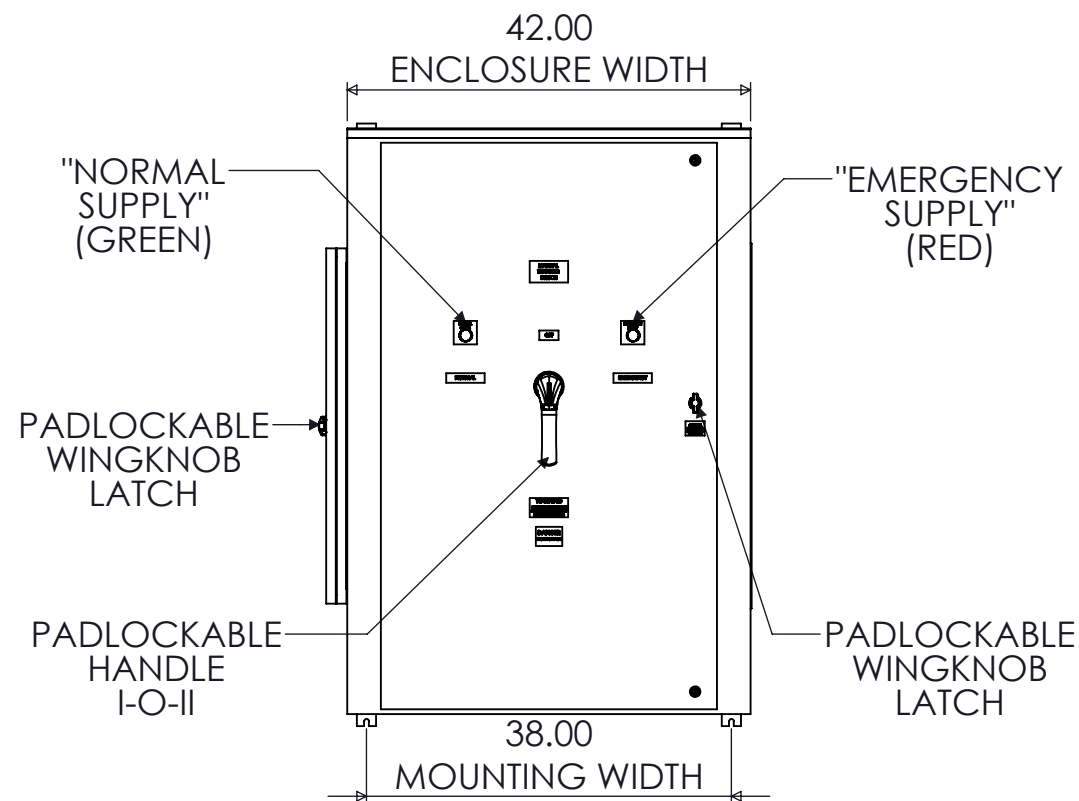

FRONT VIEW

42.00
ENCLOSURE WIDTH

"NORMAL
SUPPLY"
(GREEN)

"EMERGENCY
SUPPLY"
(RED)

PADLOCKABLE
WINGKNOB
LATCH

PADLOCKABLE
HANDLE
I-O-II

PADLOCKABLE
WINGKNOB
LATCH

38.00
MOUNTING WIDTH

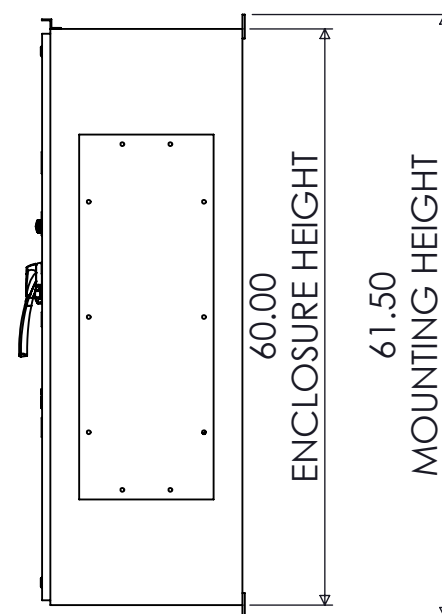

SIDE VIEW

60.00
ENCLOSURE HEIGHT

61.50
MOUNTING HEIGHT

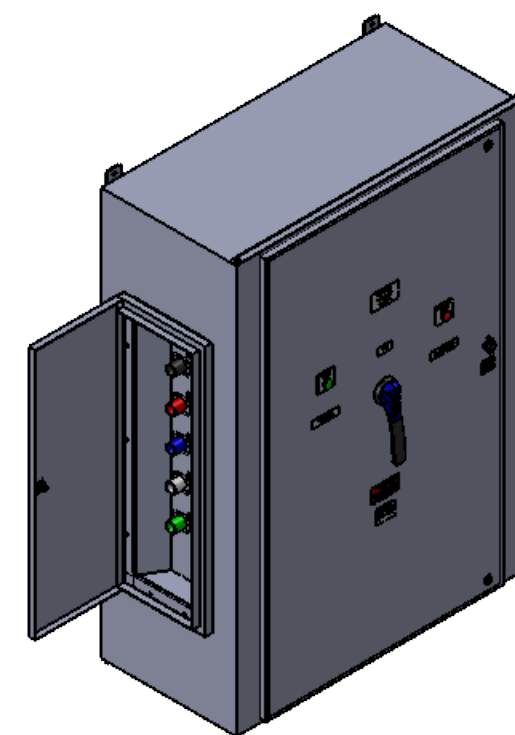

DIMETRIC VIEW

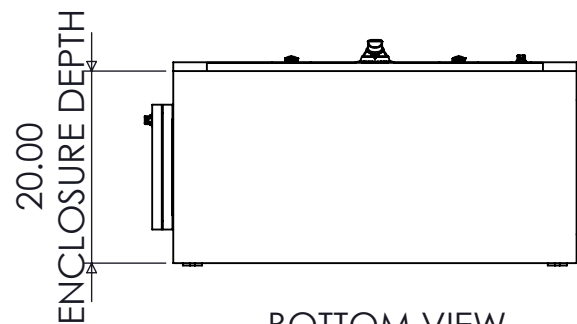

BOTTOM VIEW

20.00
ENCLOSURE DEPTH

RECEPTACLE/COVER COLOR SCHEME

	L1	L2	L3	N	GND
240VAC	BLK	RED	BLU	WHT	GRN
480VAC	BRN	ORG	YEL	WHT	GRN
600VAC	BLK	BLK	BLK	WHT	GRN

400A NON-FUSED 4-POLE NEMA 3R MANUAL TRANSFER SWITCH WITH CAM-LOKS (LEFT)

REV	DESCRIPTION	DATE	DRAWN	J.GONZALEZ
0	ORIGINAL RELEASE	1/5/17	CHECKED	
			SUP. NO	DRAWING TYPE
			SUP. BY NO	DIMENSIONAL
			PANEL NO	DRAWING NUMBER
			BUIL. NO	STS400N3RNF4CL
			GROUP NO	
			ORDER NO	



9900 TWIN LAKES PARKWAY
 CHARLOTTE, NC 28269
 704-596-5617
 PSICONTROLSOLUTIONS.COM

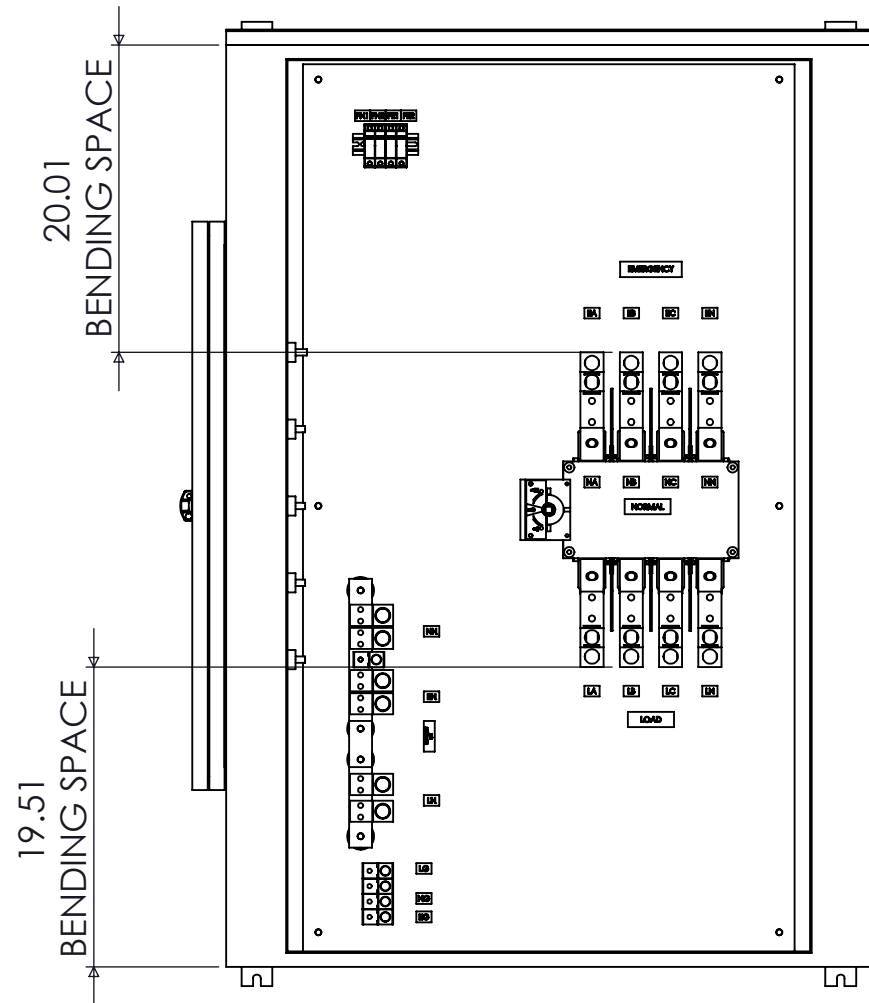

FRONT VIEW
DOOR REMOVED

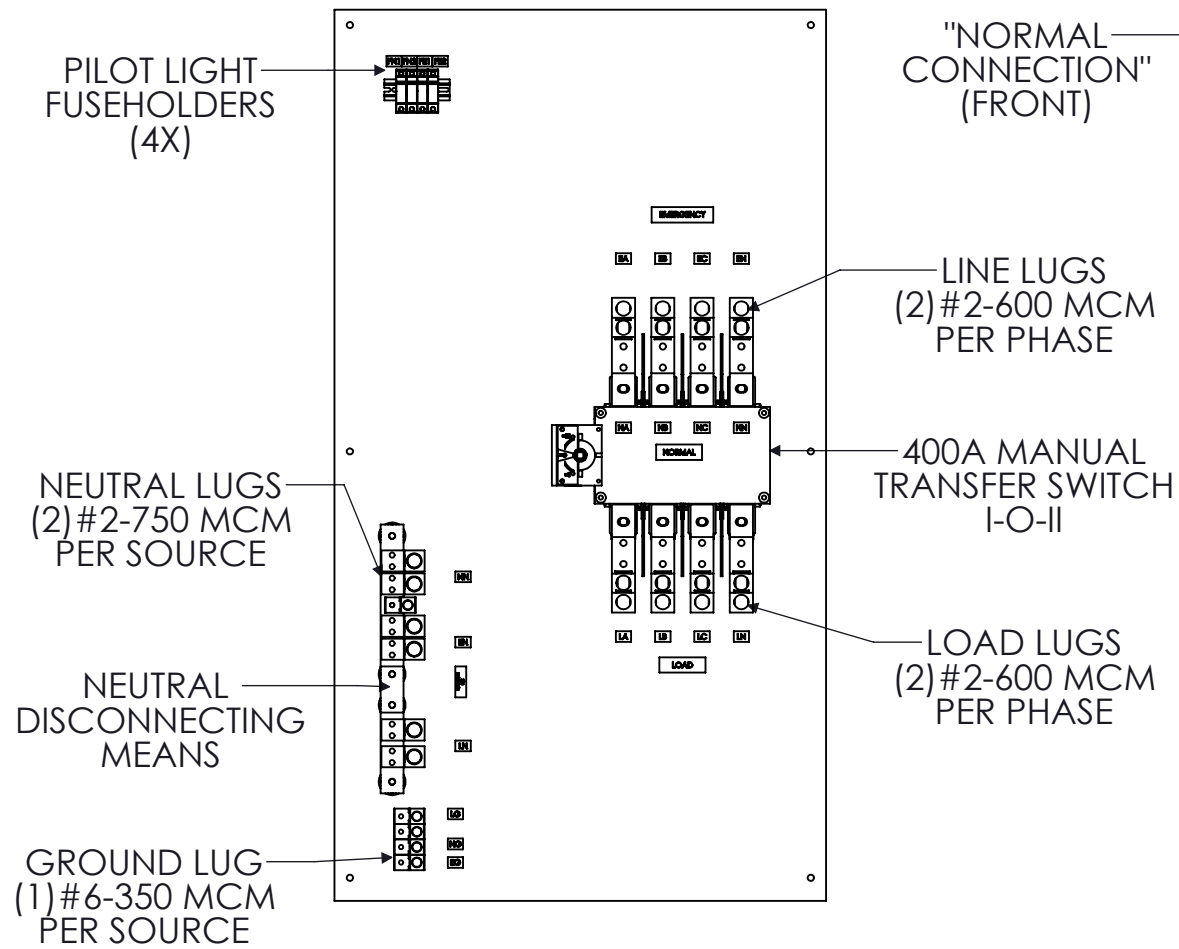

FRONT VIEW
ENCLOSURE REMOVED

"EMERGENCY CONNECTION" (CAM-LOKS)

"NORMAL CONNECTION" (FRONT)

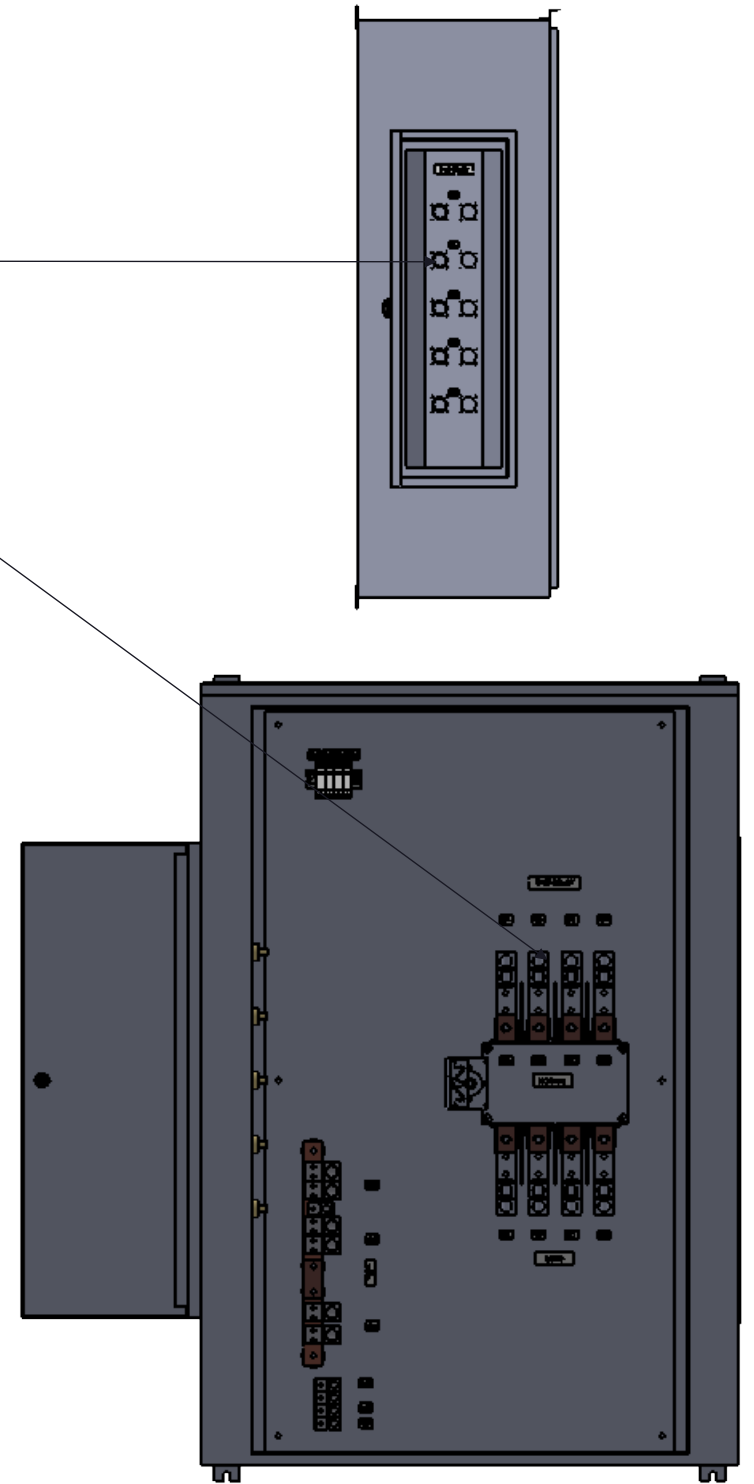

FRONT VIEW
DOOR REMOVED

400A NON-FUSED 4-POLE NEMA 3R MANUAL TRANSFER SWITCH WITH CAM-LOKS (LEFT)

REV	DESCRIPTION	DATE	DRAWN	J.GONZALEZ	CHECKED
0	ORIGINAL RELEASE	1/5/17			
				SUP. NO	
				SUP. BY NO	
				PANEL NO	
				BUL. NO	
				GROUP NO	
				ORDER NO	

DRAWING TYPE
OUTLINE

DRAWING NUMBER
STS400N3RNF4CL



9900 TWIN LAKES PARKWAY
CHARLOTTE, NC 28269
704-596-5617
PSICONTROLSOLUTIONS.COM