

TOP VIEW

SPECIFICATIONS

MAX VOLTAGE - 600VAC 3 ϕ
 RATED CURRENT - 1600 A
 IEC RATED ONLY - NO UL LISTING
 ENCLOSURE RATING - NEMA 3R
 REF. ES100145BF
 DURABILITY - 4000 CYCLES
 EST SHIPPING WEIGHT - 950LBS
 COLOR - RAL7035 LIGHT GREY

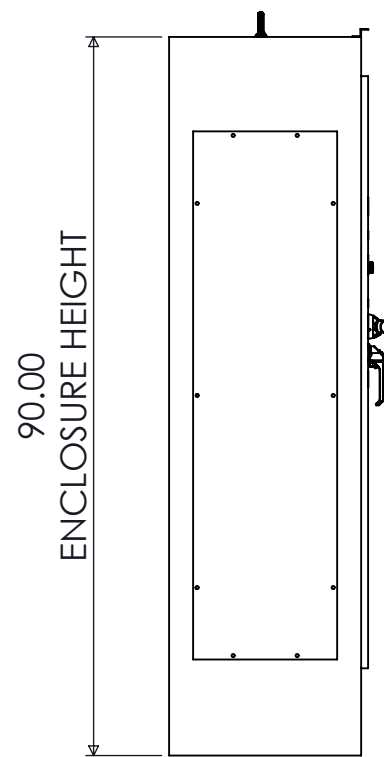

SIDE VIEW

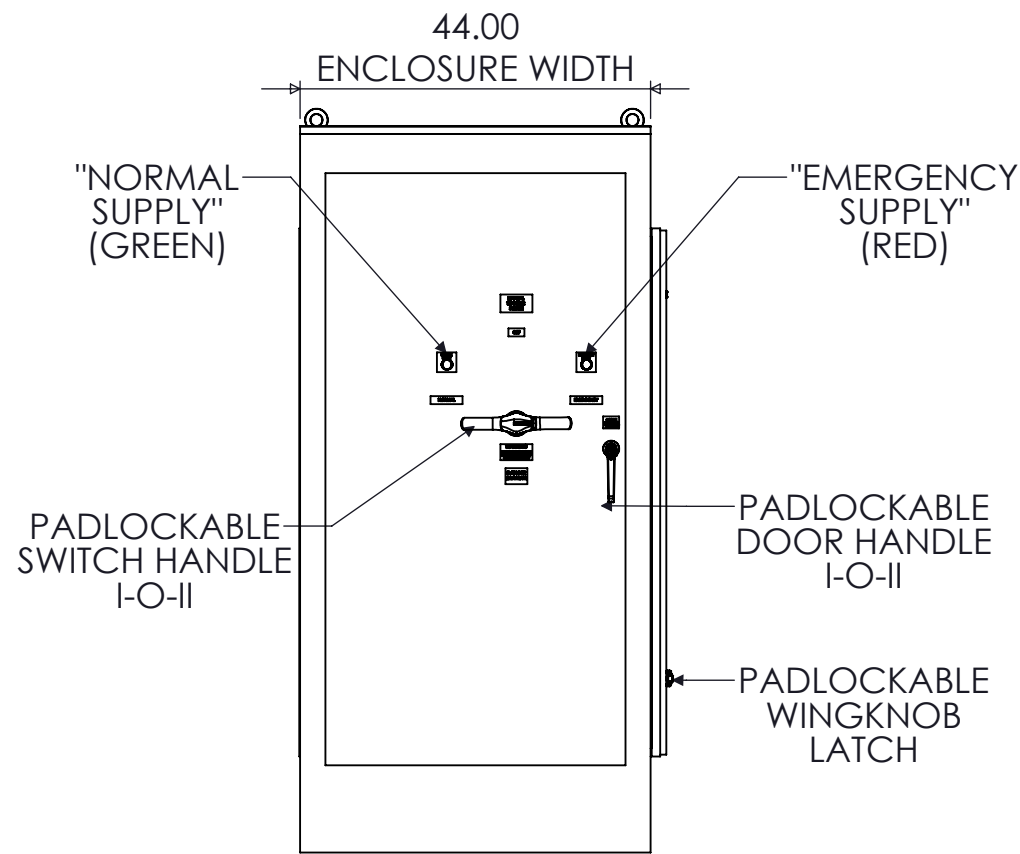

FRONT VIEW

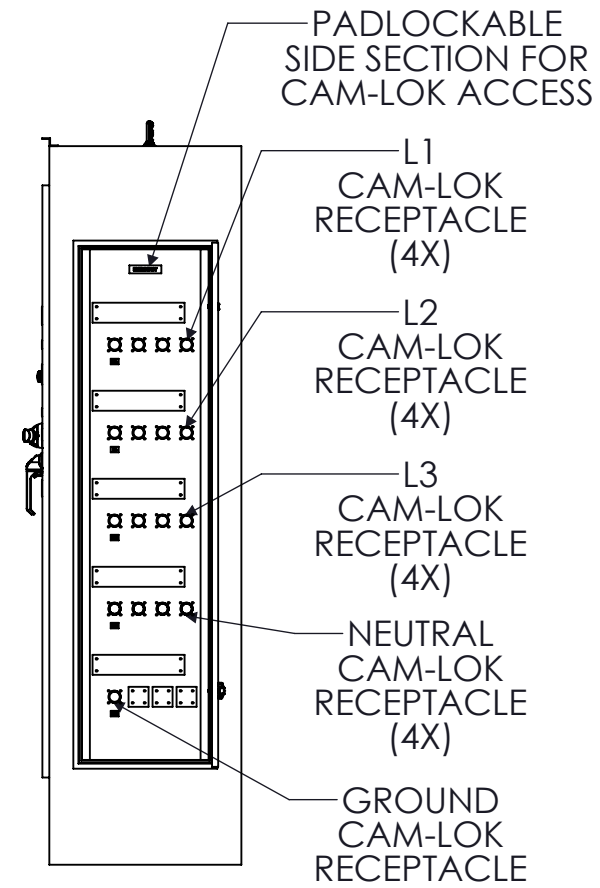

SIDE VIEW

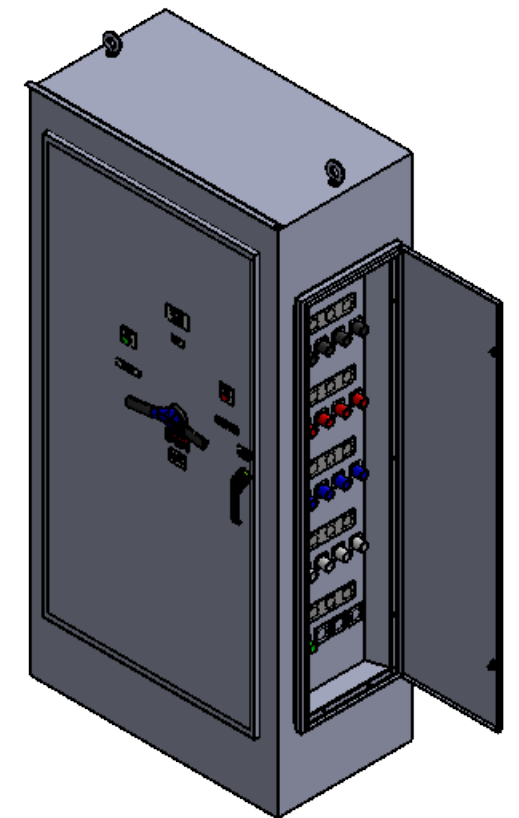

DIMETRIC VIEW

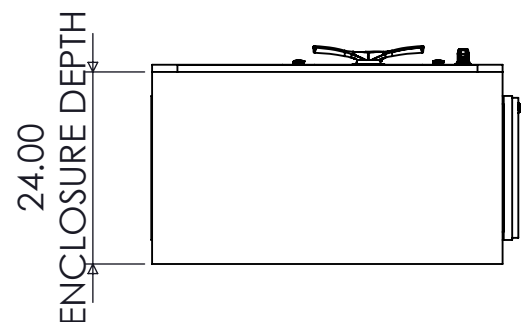

BOTTOM VIEW

RECEPTACLE/COVER COLOR SCHEME

	L1	L2	L3	N	GND
240VAC	BLK	RED	BLU	WHT	GRN
480VAC	BRN	ORG	YEL	WHT	GRN
600VAC	BLK	BLK	BLK	WHT	GRN

1600A FUSIBLE 4-POLE NEMA 3R MANUAL TRANSFER SWITCH WITH CAM-LOKS (RIGHT)

REV	DESCRIPTION	DATE	DRAWN	J.GONZALEZ
0	ORIGINAL RELEASE	1/17/17	CHECKED	
			SUP. NO	DRAWING TYPE
			SUP. BY NO	DIMENSIONAL
			PANEL NO	DRAWING NUMBER
			BUIL. NO	STS1600N3RBF4CR
			GROUP NO	
			ORDER NO	



9900 TWIN LAKES PARKWAY
 CHARLOTTE, NC 28269
 704-596-5617
 PSICONTROLSOLUTIONS.COM

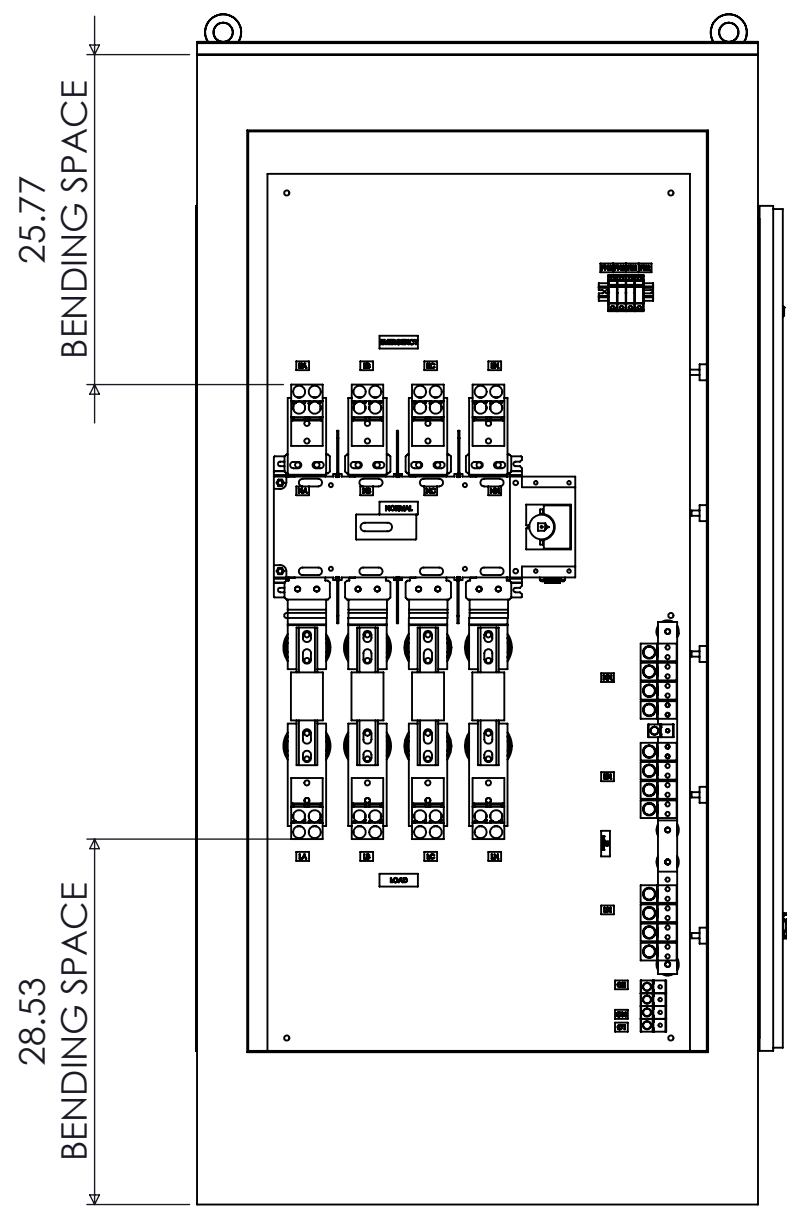

FRONT VIEW
DOOR REMOVED

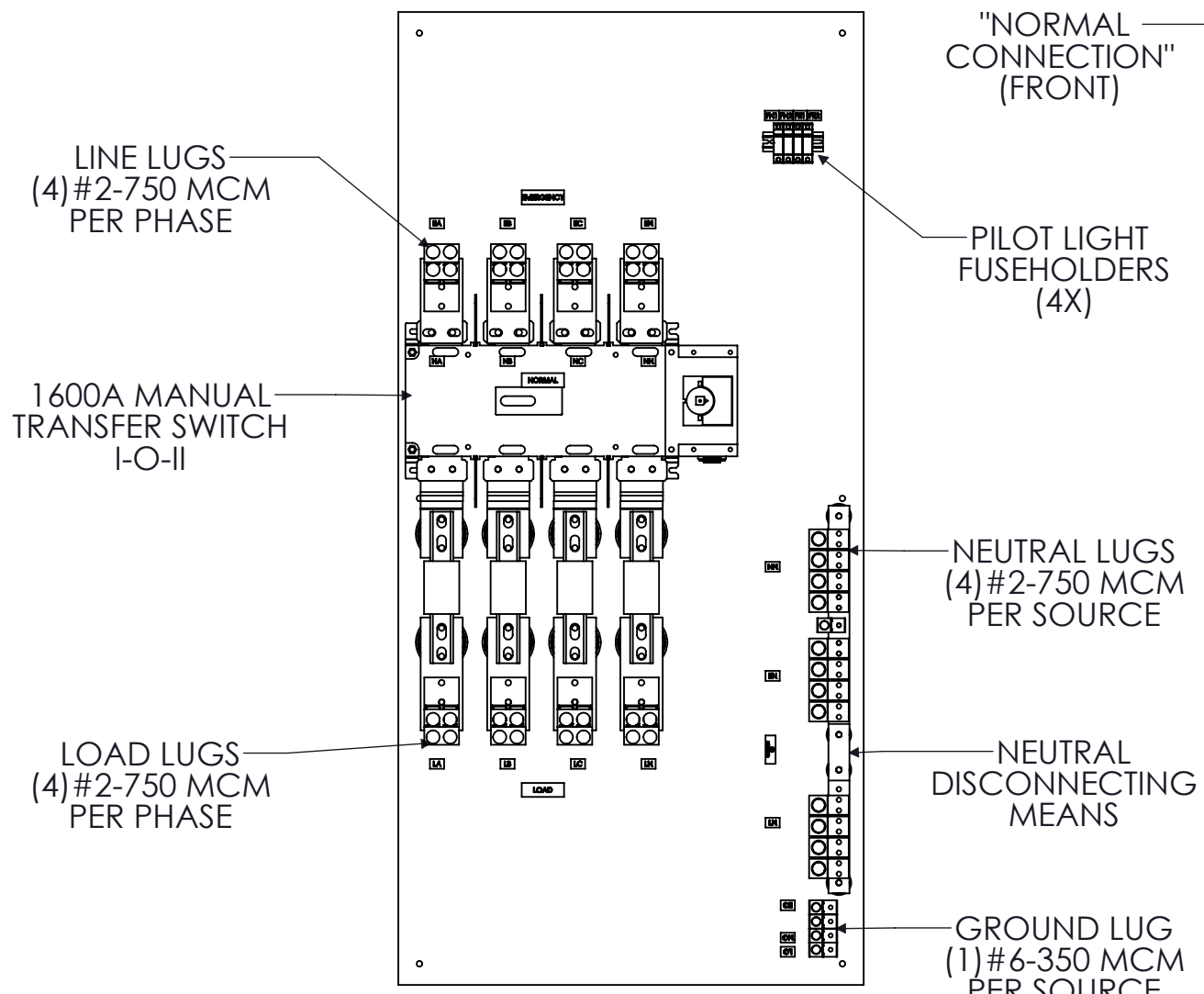

FRONT VIEW
ENCLOSURE REMOVED

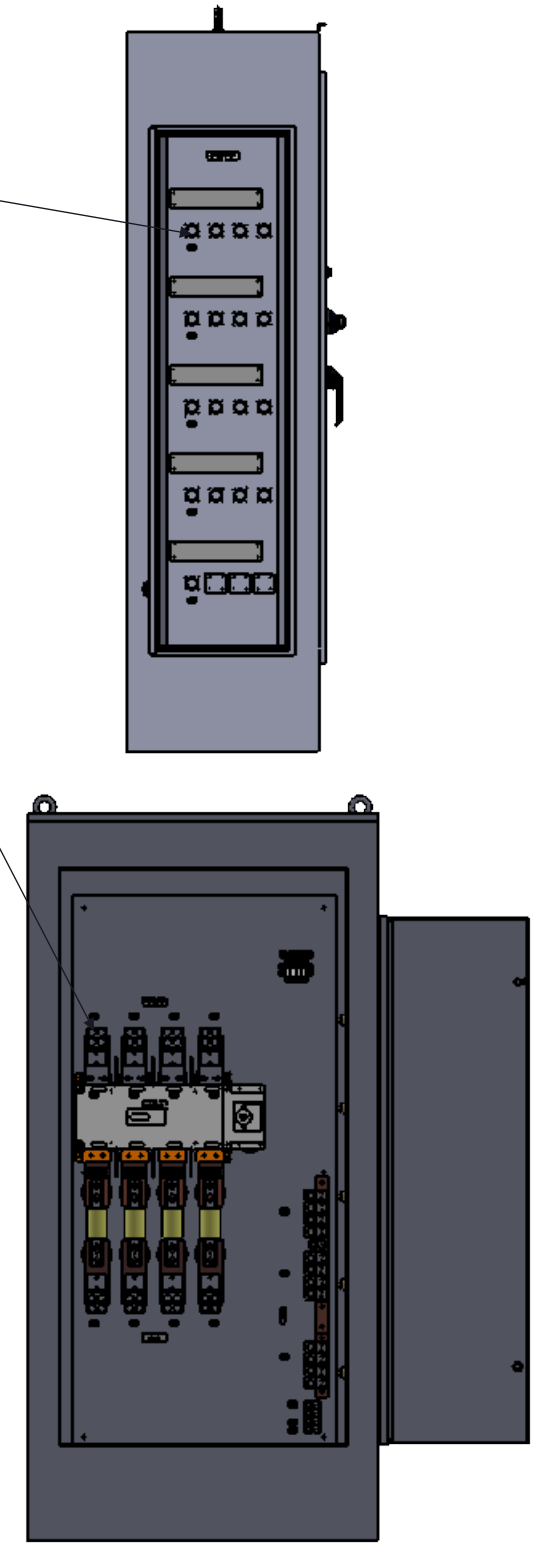

FRONT VIEW
DOOR REMOVED

NOTE: FUSES PROVIDED IF PURCHASED
208-600VAC : KRP-C-1600SP



9900 TWIN LAKES PARKWAY
CHARLOTTE, NC 28269
704-596-5617
PSICONTROLSOLUTIONS.COM

1600A FUSIBLE 4-POLE NEMA 3R MANUAL TRANSFER SWITCH WITH CAM-LOKS (RIGHT)			
REV	DESCRIPTION	DATE	DRAWN J.GONZALEZ
0	ORIGINAL RELEASE	1/30/17	CHECKED
			SUP. NO
			SUP. BY NO
			PANEL NO
			BUL. NO
			GROUP NO
			ORDER NO

DRAWING TYPE	OUTLINE
DRAWING NUMBER	STS1600N3RBF4CR