

SPECIFICATIONS

MAX VOLTAGE - 600VAC 3 ϕ
 RATED CURRENT - 1200 A
 STANDARDS - UL508A
 ENCLOSURE RATING - NEMA 3R
 REF. ES100145NF
 DURABILITY - 3550 CYCLES
 EST SHIPPING WEIGHT - 925LBS
 COLOR - RAL7035 LIGHT GREY

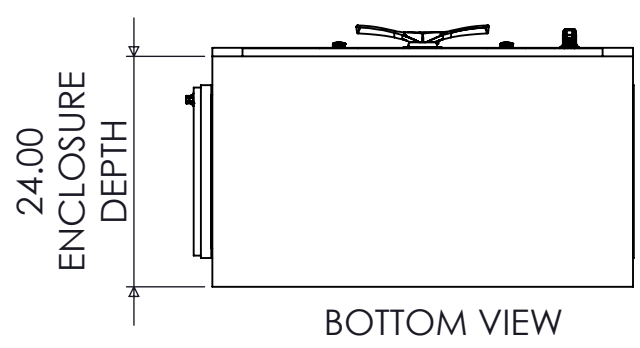
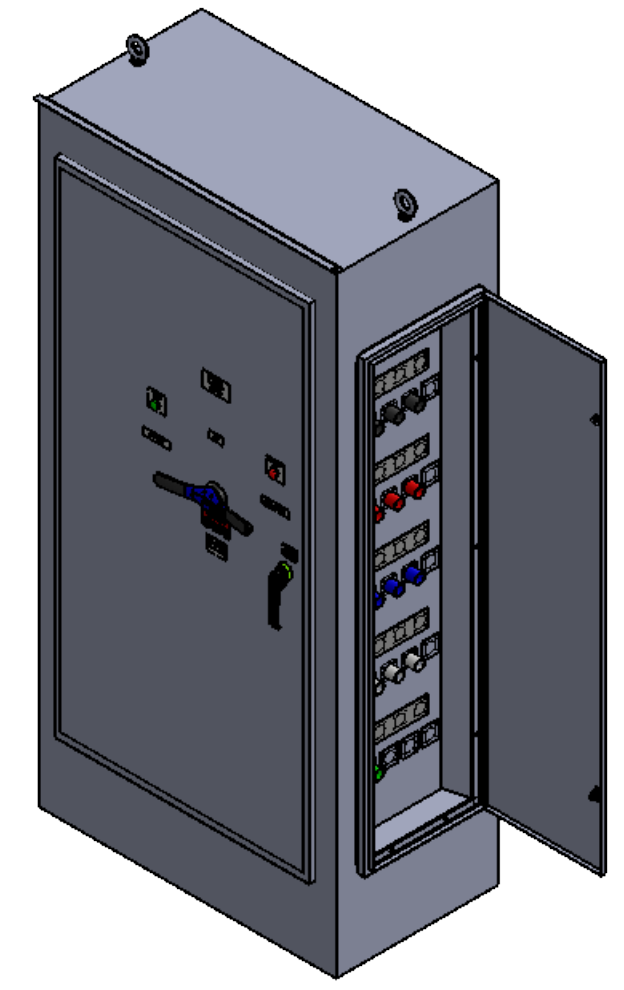
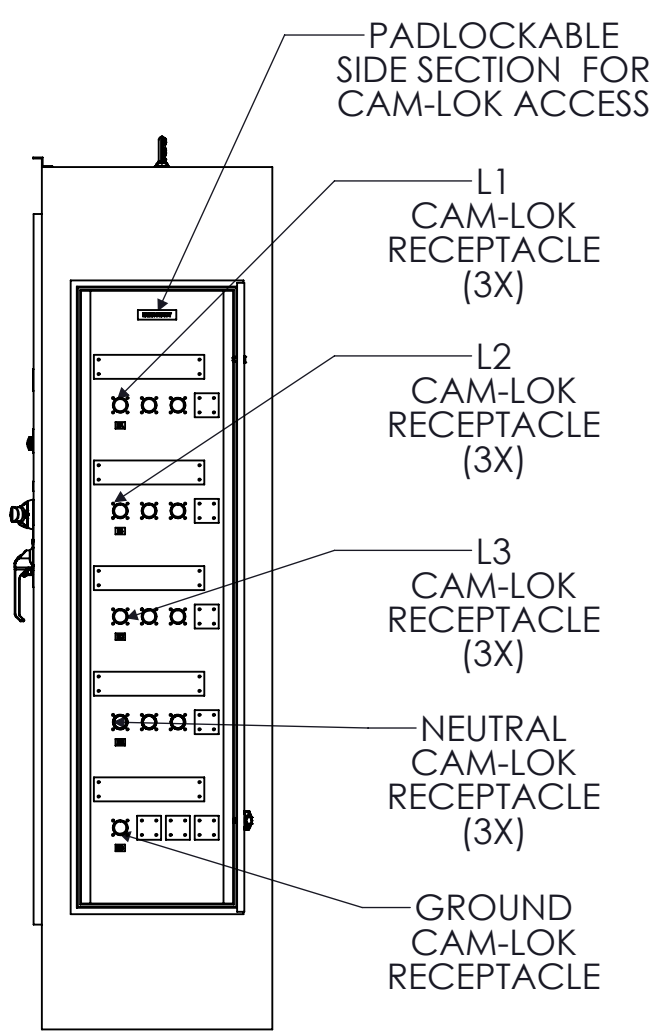
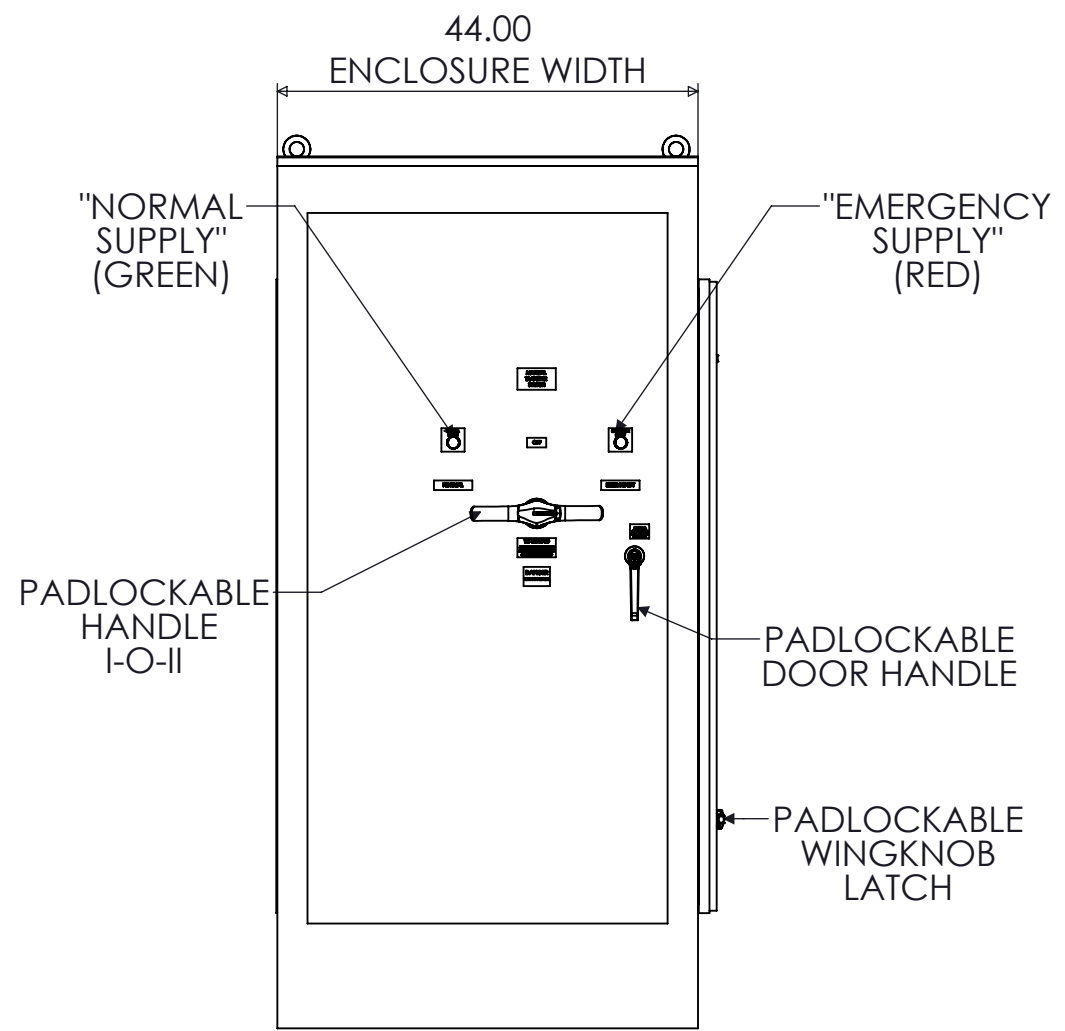
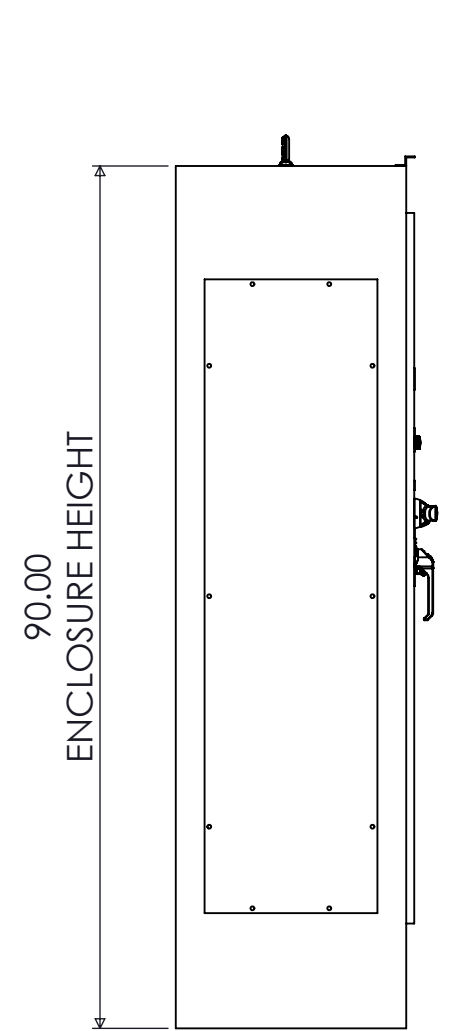
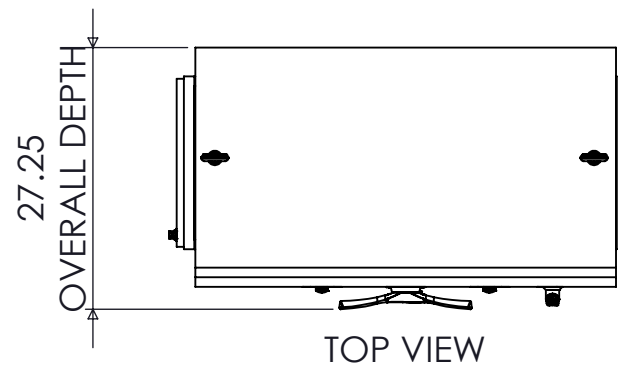

RECEPTACLE/COVER COLOR SCHEME

	L1	L2	L3	N	GND
240VAC	BLK	RED	BLU	WHT	GRN
480VAC	BRN	ORG	YEL	WHT	GRN
600VAC	BLK	BLK	BLK	WHT	GRN

1200A NON-FUSED 4-POLE NEMA 3R MANUAL TRANSFER SWITCH WITH CAM-LOKS (RIGHT)					
REV	DESCRIPTION	DATE	DRAWN	J.GONZALEZ	
0	ORIGINAL RELEASE	1/23/17	CHECKED		
			SUP. NO	DRAWING TYPE	
			SUP. BY NO	DIMENSIONAL	
			PANEL NO	DRAWING NUMBER	
			BUIL. NO	STS1200N3RNF4CR	
			GROUP NO		
			ORDER NO		



9900 TWIN LAKES PARKWAY
 CHARLOTTE, NC 28269
 704-596-5617
 PSICONTROLSOLUTIONS.COM

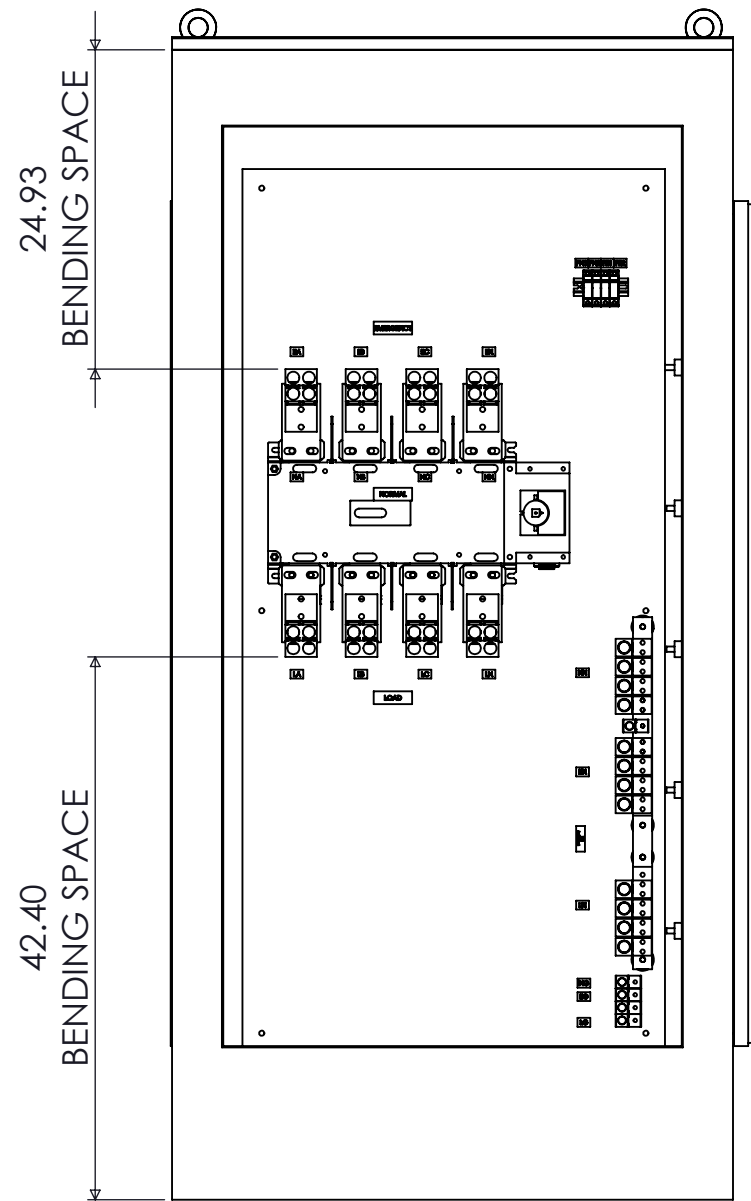

FRONT VIEW
DOOR REMOVED

LINE LUGS
(4) #2-750 MCM
PER PHASE

1200A MANUAL
TRANSFER SWITCH
I-O-II

LOAD LUGS
(4) #2-750 MCM
PER PHASE

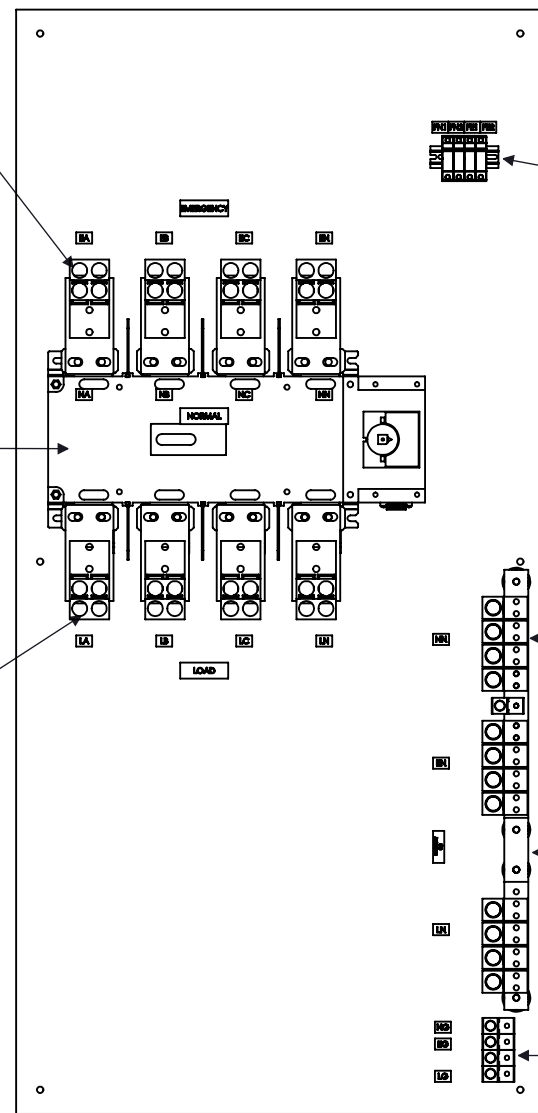

FRONT VIEW
ENCLOSURE REMOVED

"EMERGENCY
CONNECTION"
(CAM-LOKS)

PILOT LIGHT
FUSEHOLDERS
(4X)

"NORMAL
CONNECTION"
(FRONT)

NEUTRAL LUGS
(4) #2-750 MCM
PER SOURCE

NEUTRAL
DISCONNECTING
MEANS

GROUND LUG
(1) #6-350 MCM
PER SOURCE

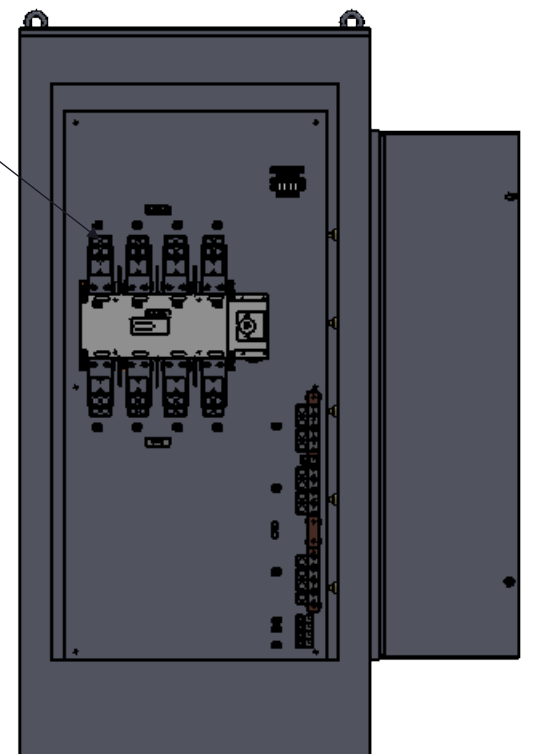
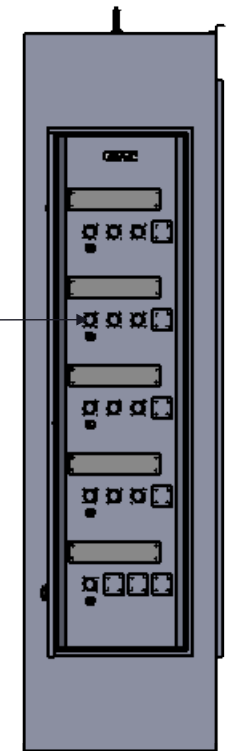

FRONT VIEW
DOOR REMOVED

1200A NON-FUSED 4-POLE NEMA 3R MANUAL TRANSFER SWITCH WITH CAM-LOKS (RIGHT)

REV	DESCRIPTION	DATE	DRAWN	J.GONZALEZ	CHECKED
0	ORIGINAL RELEASE	1/23/17			
			SUP. NO		DRAWING TYPE
			SUP. BY NO		OUTLINE
			PANEL NO		DRAWING NUMBER
			BUL. NO		STS1200N3RNF4CR
			GROUP NO		
			ORDER NO		