

SPECIFICATIONS

MAX VOLTAGE - 600VAC 3 ϕ
 RATED CURRENT - 60 A
 STANDARDS - UL508A
 ENCLOSURE RATING - NEMA 1
 REF. ES100145BF
 DURABILITY - 100,000 CYCLES
 EST SHIPPING WEIGHT - 60LBS

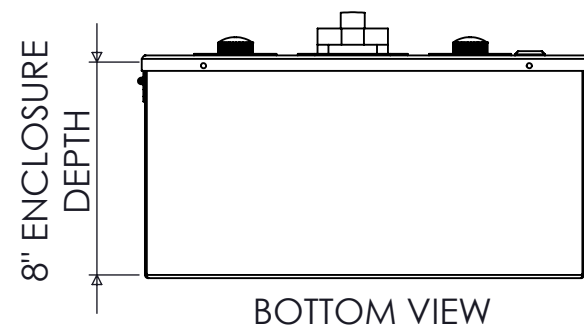
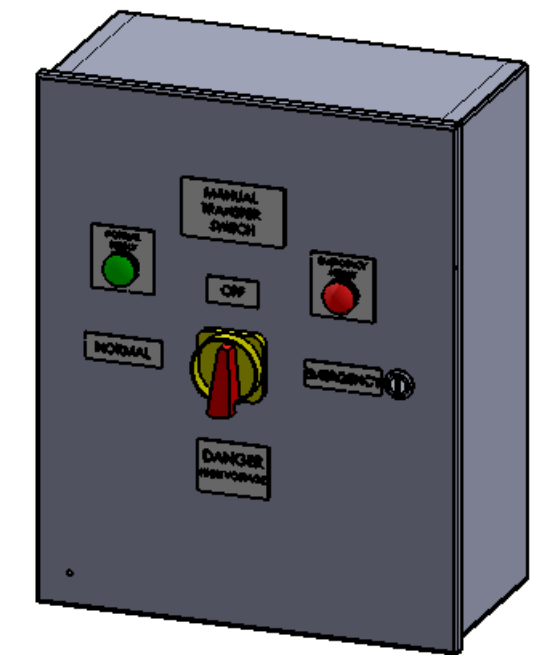
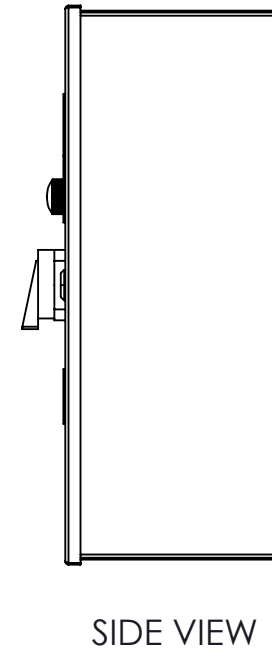
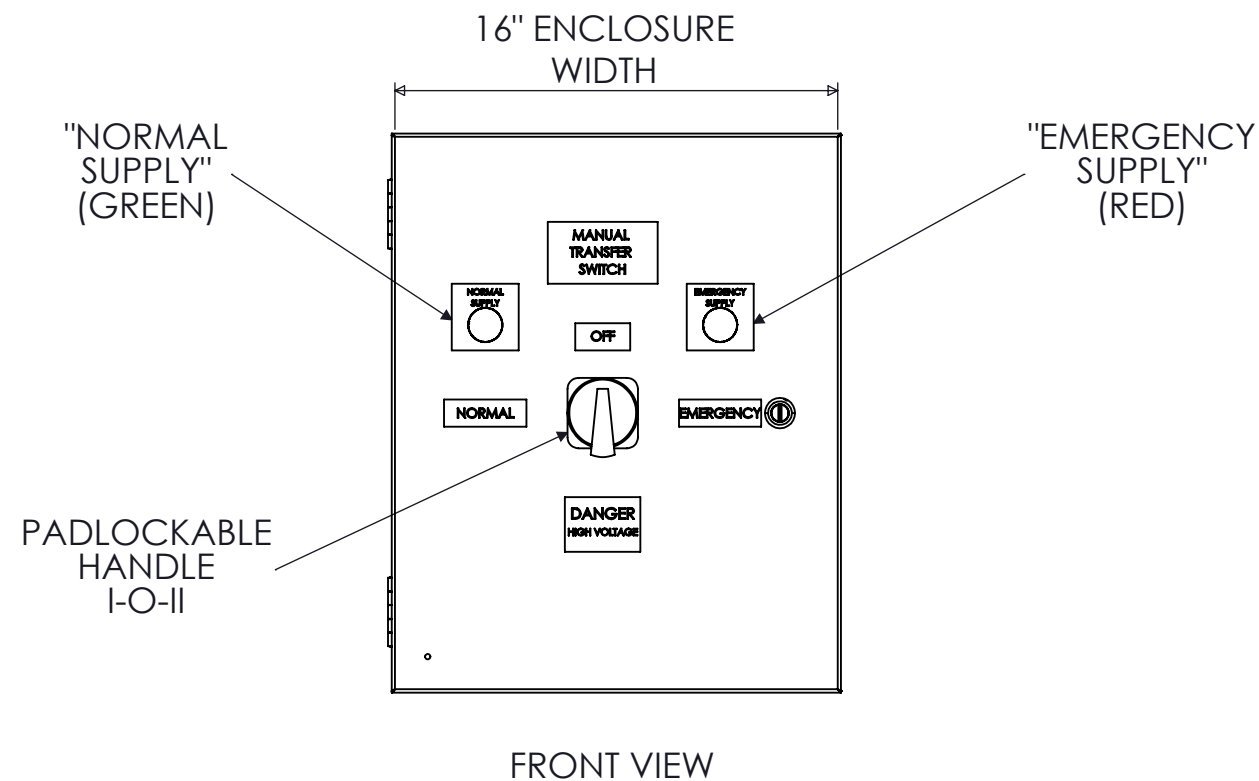
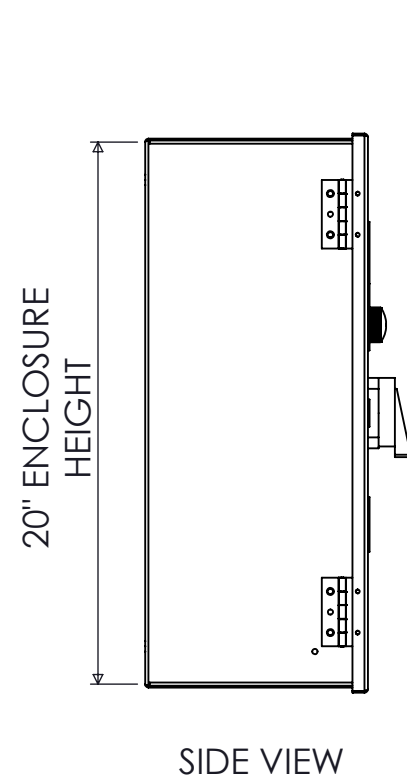
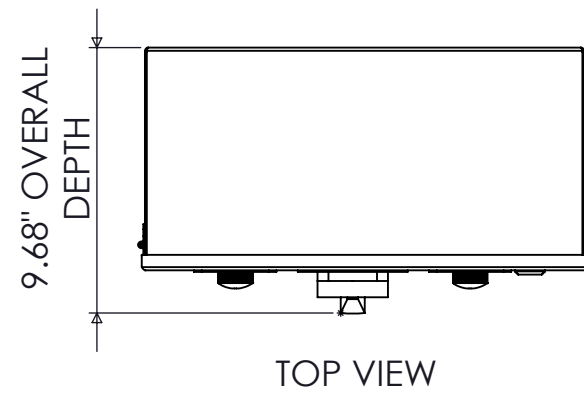

| 60A FUSIBLE 3-POLE NEMA 1 MANUAL TRANSFER SWITCH | | | |
|--|------------------|---------|--------------------|
| REV | DESCRIPTION | DATE | DRAWN S.RICHARDSON |
| 0 | ORIGINAL RELEASE | 7/24/14 | CHECKED |
| | | | SUP. NO |
| | | | SUP. BY NO |
| | | | PANEL NO |
| | | | BUL. NO |
| | | | GROUP NO |
| | | | ORDER NO |

 9900 TWIN LAKES PARKWAY
 CHARLOTTE, NC 28269
 704-596-5617
 PSICONTROLSOLUTIONS.COM

DRAWING TYPE
DIMENSIONAL
 DRAWING NUMBER
STS60N1BF3

3.10"
ALLOW 3" MINIMUM
BENDING SPACE

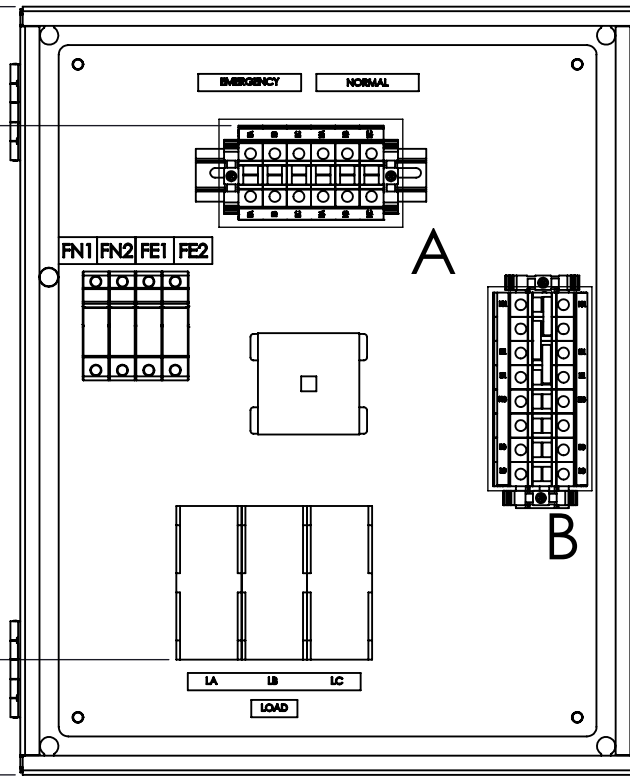

FRONT VIEW
DOOR REMOVED

3.00"
ALLOW 3" MINIMUM
BENDING SPACE

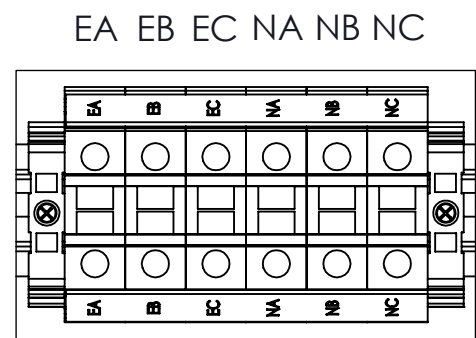

TERMINAL
LAYOUT
"A"

"EMERGENCY"
CONNECTIONS
(1) #14-1/0 AWG

PILOT LIGHT
FUSEHOLDERS
(4X)

60A MANUAL
TRANSFER SWITCH
I-O-II

60A
FUSEBLOCK
(1) #14-#2 AWG

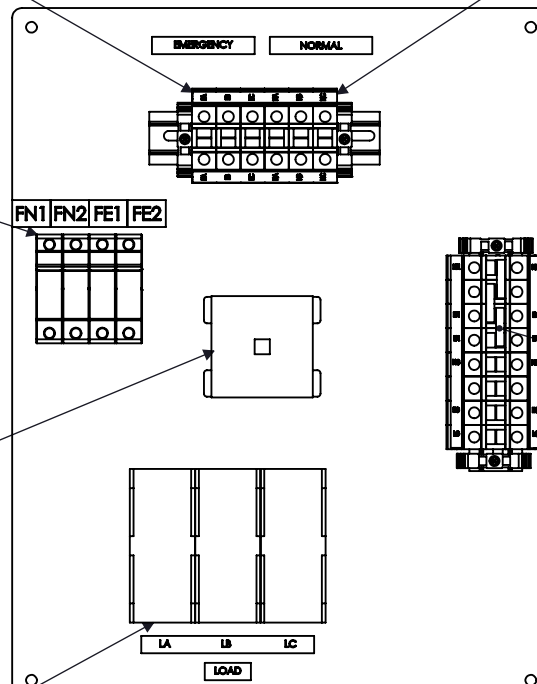

FRONT VIEW
ENCLOSURE REMOVED

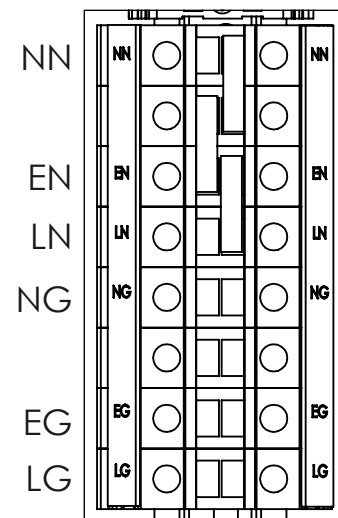

TERMINAL
LAYOUT
"B"

"NORMAL"
CONNECTIONS
(1) #14-1/0 AWG

NEUTRAL
CONNECTIONS
(1) #14-1/0 AWG

NEUTRAL
DISCONNECTING
MEANS

GROUND
CONNECTIONS
(1) #14-1/0 AWG

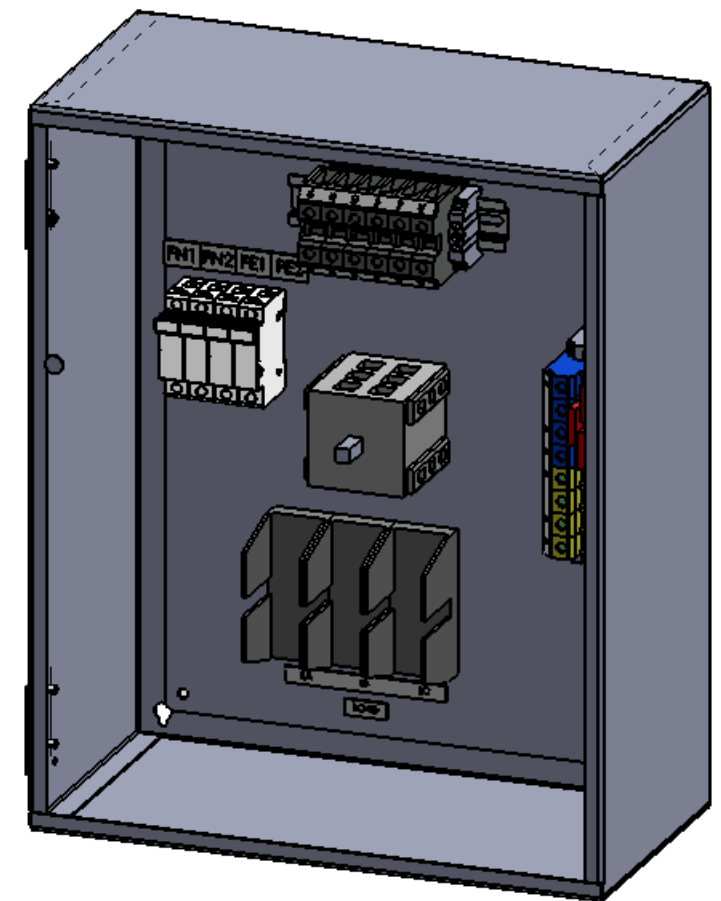

DIMETRIC VIEW
DOOR REMOVED

NOTE: FUSES PROVIDED IF PURCHASED
208-240VAC : FRN-R-60
480VAC : LPJ-60SP

60A FUSIBLE 3-POLE NEMA 1 MANUAL TRANSFER SWITCH

| REV | DESCRIPTION | DATE | DRAWN | S.RICHARDSON | |
|-----|------------------|---------|------------|--------------|----------------|
| 0 | ORIGINAL RELEASE | 7/24/14 | CHECKED | | |
| | | | SUP. NO | | DRAWING TYPE |
| | | | SUP. BY NO | | OUTLINE |
| | | | PANEL NO | | DRAWING NUMBER |
| | | | BUIL. NO | | STS60N1BF3 |
| | | | GROUP NO | | |
| | | | ORDER NO | | |

 9900 TWIN LAKES PARKWAY
 CHARLOTTE, NC 28269
 704-596-5617
 PSICONTROLSOLUTIONS.COM