

SPECIFICATIONS

MAX VOLTAGE - 600VAC 3 ϕ
 RATED CURRENT - 3000 A
 ENCLOSURE RATING - NEMA 1
 REF. ES100145NF
 DURABILITY - 3000 CYCLES
 EST SHIPPING WEIGHT - 900LBS

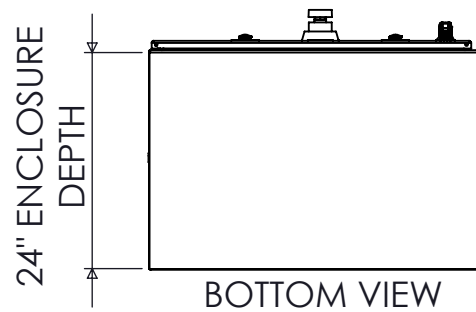
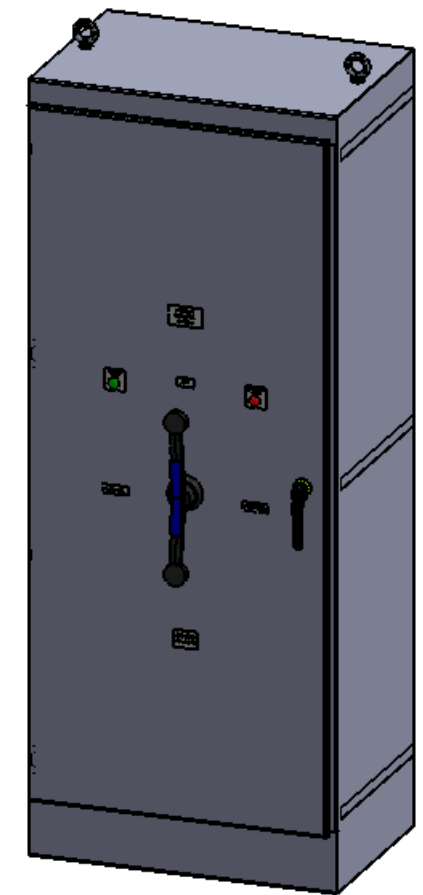
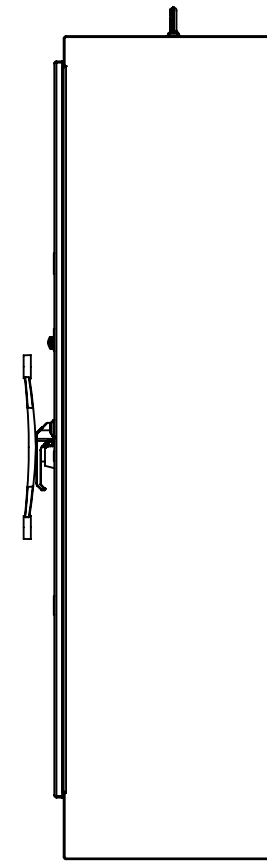
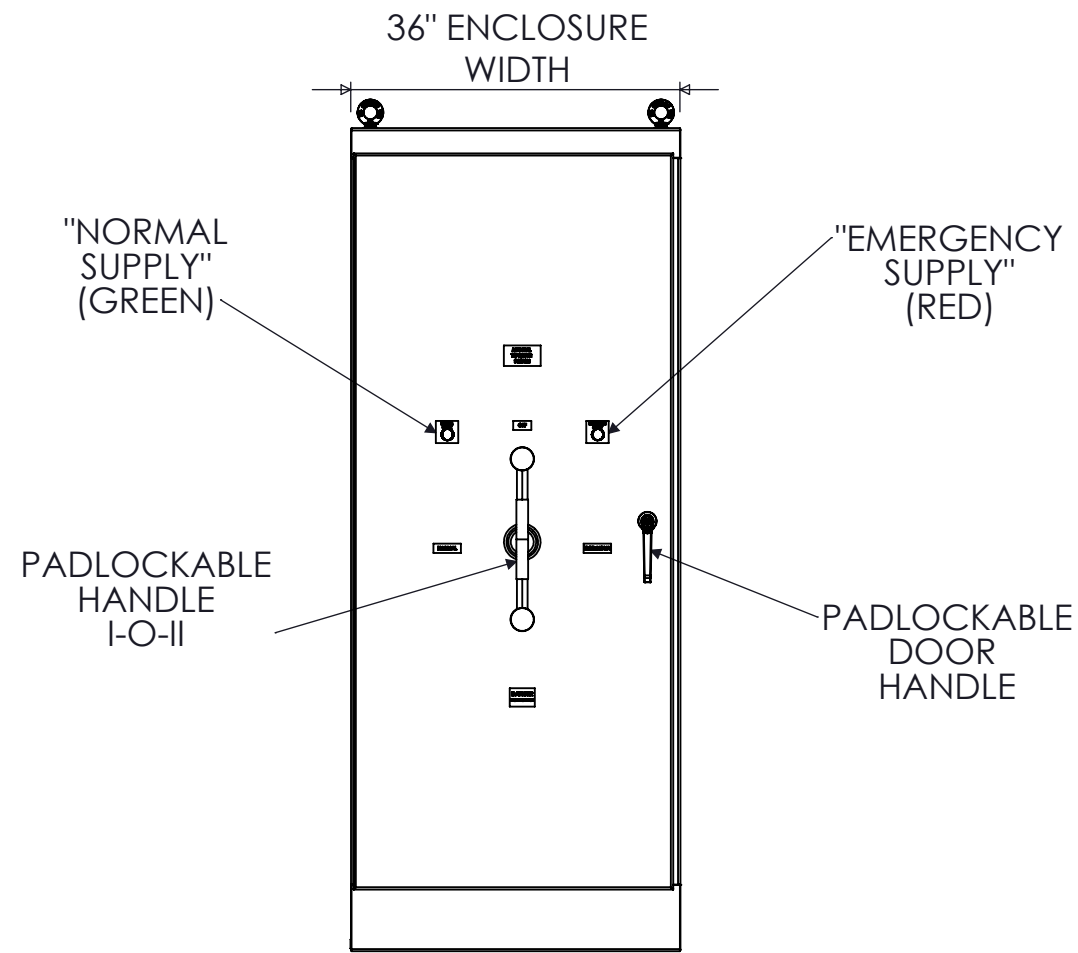
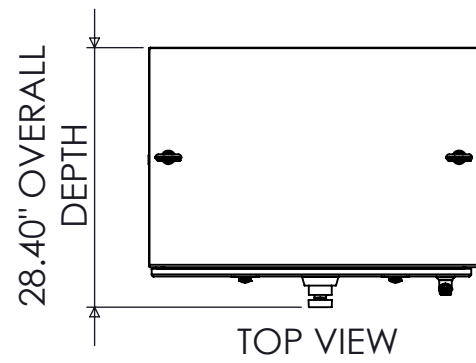

3000A NON-FUSED 3-POLE NEMA 1 MANUAL TRANSFER SWITCH

REV	DESCRIPTION	DATE	DRAWN	S.RICHARDSON	CHECKED
0	ORIGINAL RELEASE	3/13/14			
				SUP. NO	DRAWING TYPE
				SUP. BY NO	DIMENSIONAL
				PANEL NO	DRAWING NUMBER
				BUL. NO	STS3000N1NF3
				GROUP NO	
				ORDER NO	



9900 TWIN LAKES PARKWAY
 CHARLOTTE, NC 28269
 704-596-5617
 PSICONTROLSOLUTIONS.COM

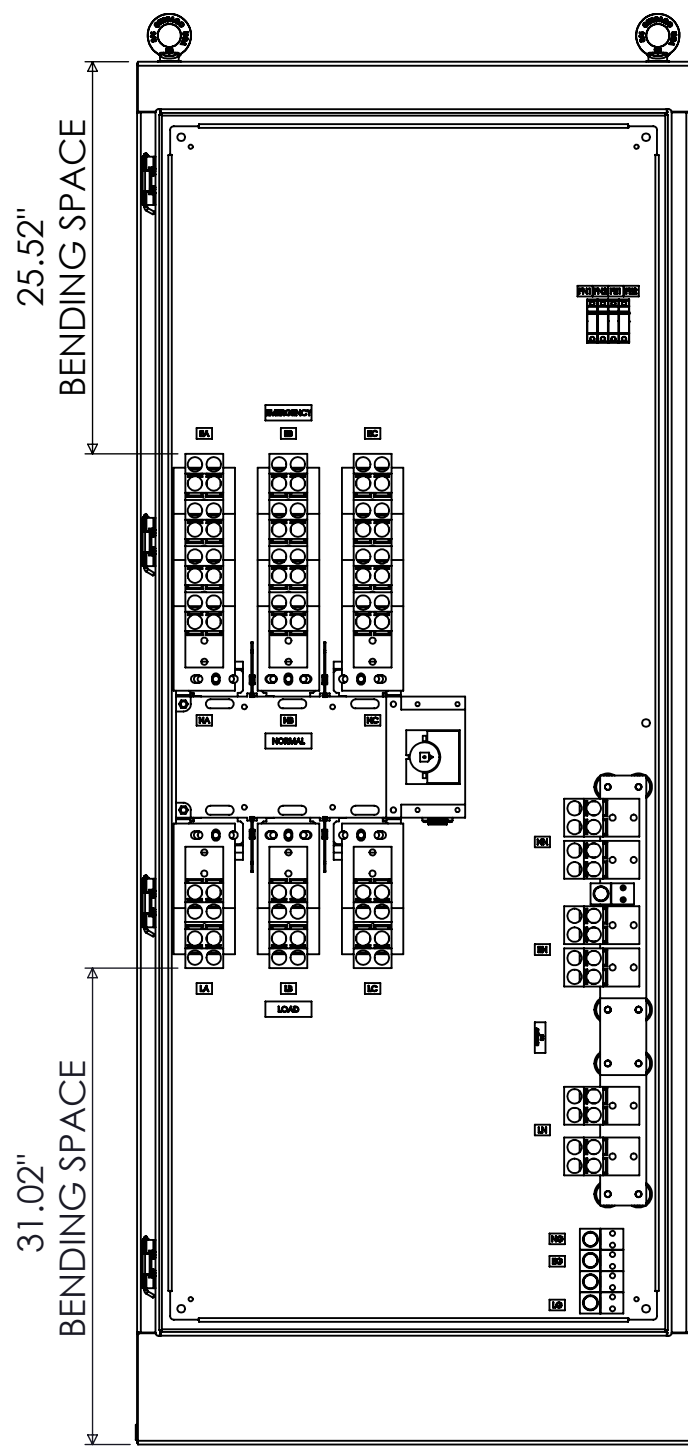

FRONT VIEW
DOOR REMOVED

PILOT LIGHT
FUSEHOLDERS
(4X)

LINE LUGS
(8) #2-600 MCM

3000A MANUAL
TRANSFER SWITCH
I-O-II

LOAD LUGS
(8) #2-600 MCM

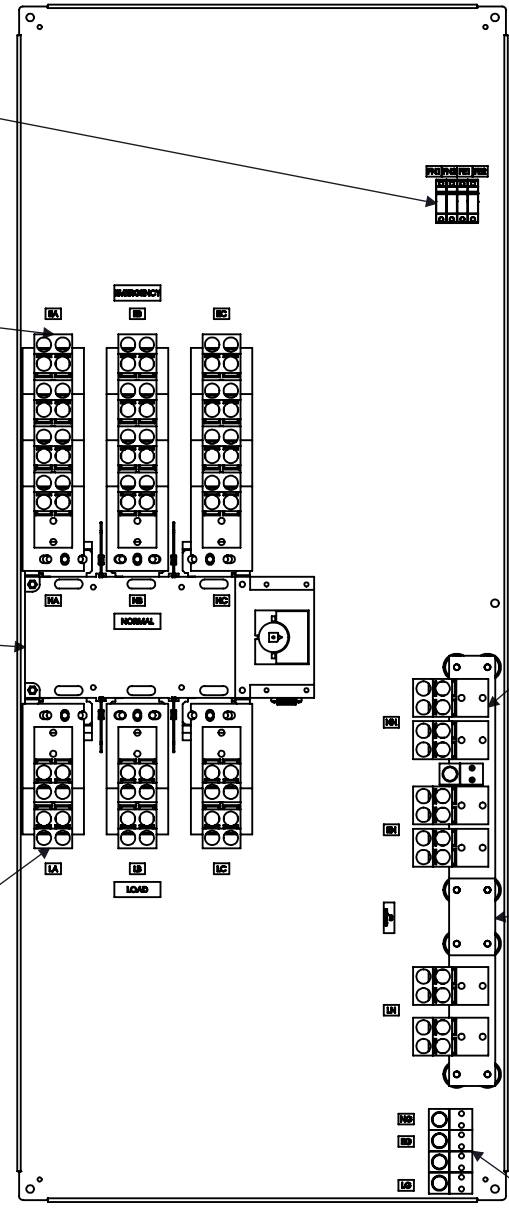

FRONT VIEW
ENCLOSURE REMOVED

"EMERGENCY"
CONNECTIONS
(REAR SET)

"NORMAL"
CONNECTIONS
(FRONT SET)

NEUTRAL LUGS
(8) #2-600 MCM

NEUTRAL
DISCONNECTING
MEANS

GROUND LUGS
(1) #2-750 MCM

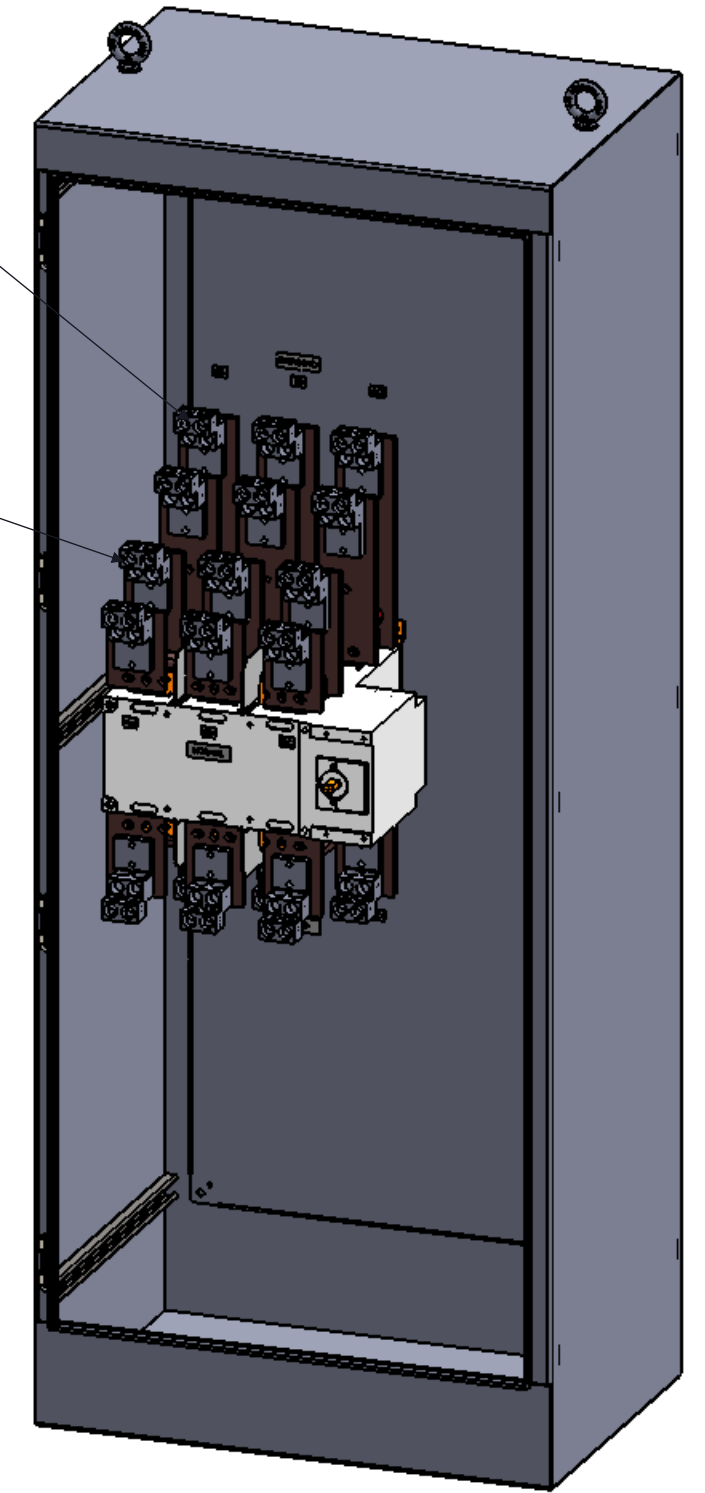

DIMETRIC VIEW
DOOR REMOVED

3000A NON-FUSED 3-POLE NEMA 1 MANUAL TRANSFER SWITCH

REV	DESCRIPTION	DATE	DRAWN	S.RICHARDSON
0	ORIGINAL RELEASE	3/13/14	CHECKED	
			SUP. NO	
			SUP. BY NO	
			PANEL NO	
			BUL. NO	
			GROUP NO	
			ORDER NO	

DRAWING TYPE
OUTLINE

DRAWING NUMBER
STS3000N1NF3



9900 TWIN LAKES PARKWAY
CHARLOTTE, NC 28269
704-596-5617
PSICONTROLSOLUTIONS.COM