

SPECIFICATIONS

MAX VOLTAGE - 480VAC 3 ϕ
 UL1008 RATED CURRENT - 200 A
 STANDARDS - UL508A
 ENCLOSURE RATING - NEMA 4X
 REF. ES100145SE3
 SWITCH SCCR - 100kA @ 480VAC
 DURABILITY - 6050 CYCLES
 EST SHIPPING WEIGHT - 150LBS

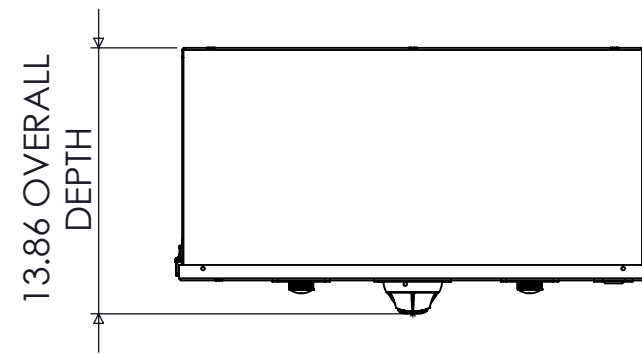

TOP VIEW

24.00
ENCLOSURE WIDTH

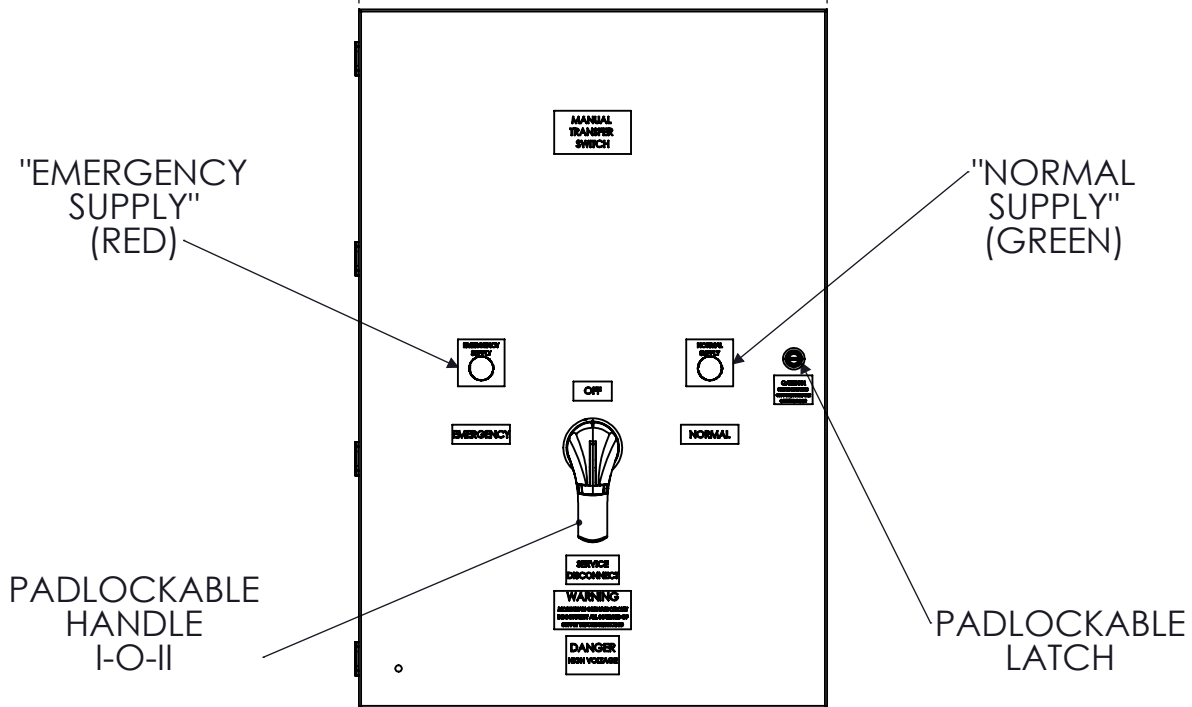

FRONT VIEW

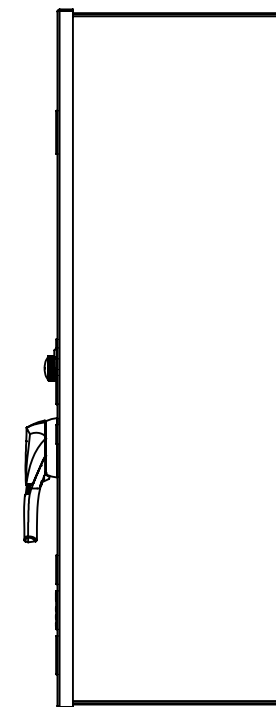

RIGHT VIEW

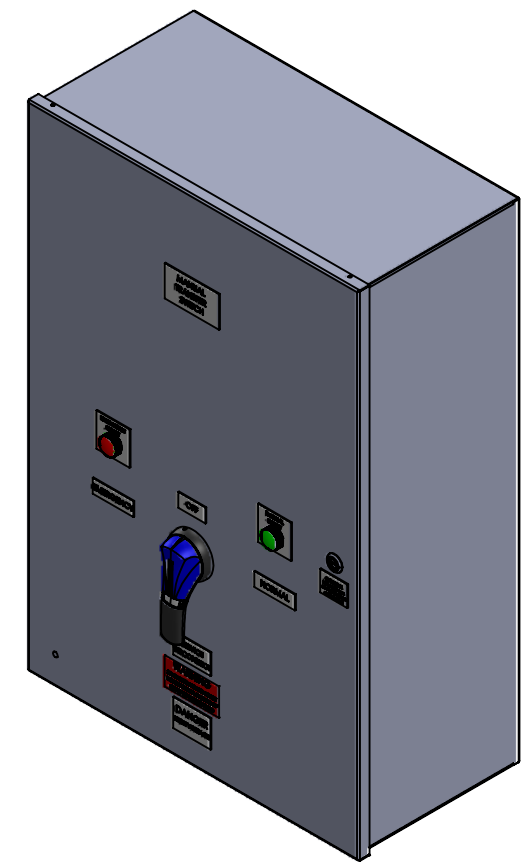

DIMETRIC VIEW

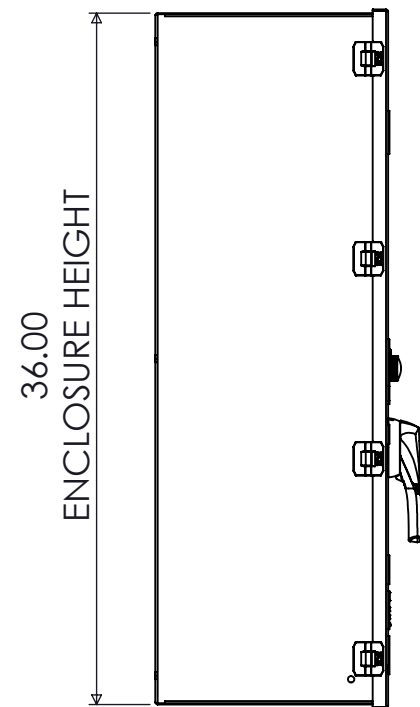

LEFT VIEW

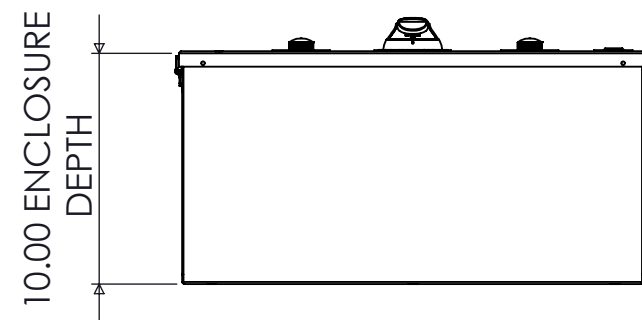

BOTTOM VIEW

200A SE-RATED 3-POLE NEMA 4X MANUAL TRANSFER SWITCH

REV	DESCRIPTION	DATE	DRAWN	C. JUNG	
0	ORIGINAL RELEASE	9/15/17	CHECKED		
1	FUSES MOVED	10/19/21	SUP. NO		DRAWING TYPE
2	HARD BUS ADDED	02/27/22	SUP. BY NO		DIMENSIONAL
			PANEL NO		DRAWING NUMBER
			BUL. NO		STS200N4XSE3
			GROUP NO		
			ORDER NO		

PSI
 Power & Controls
 9900 TWIN LAKES PARKWAY
 CHARLOTTE, NC 28269
 704-596-5617
 PSICONTROLSOLUTIONS.COM

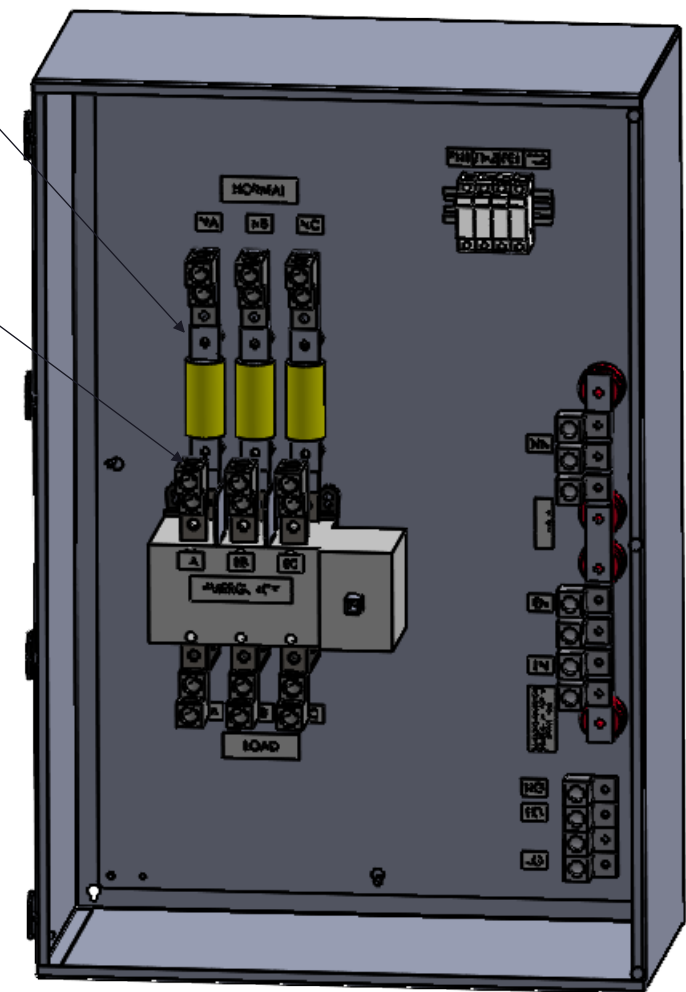
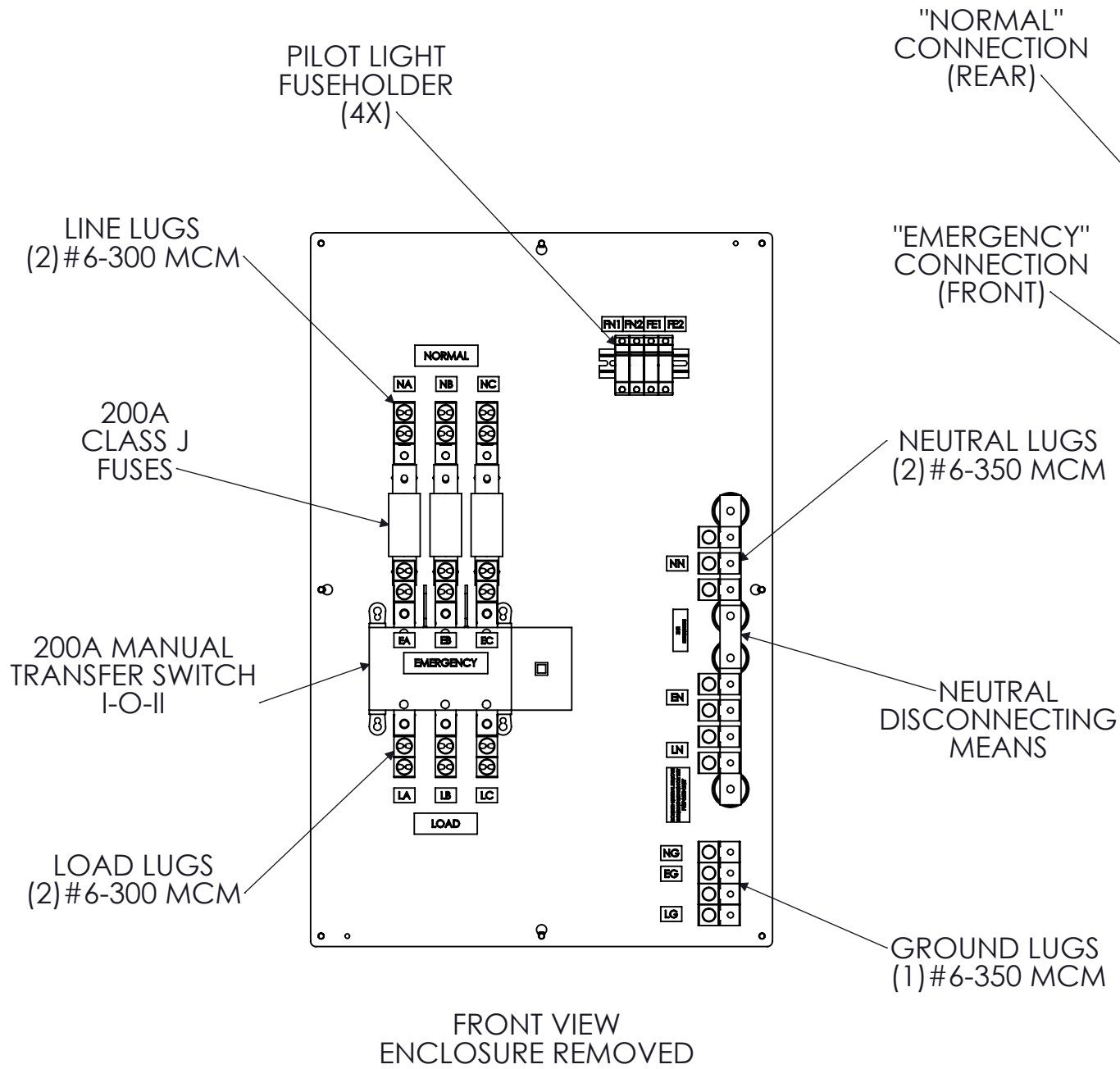
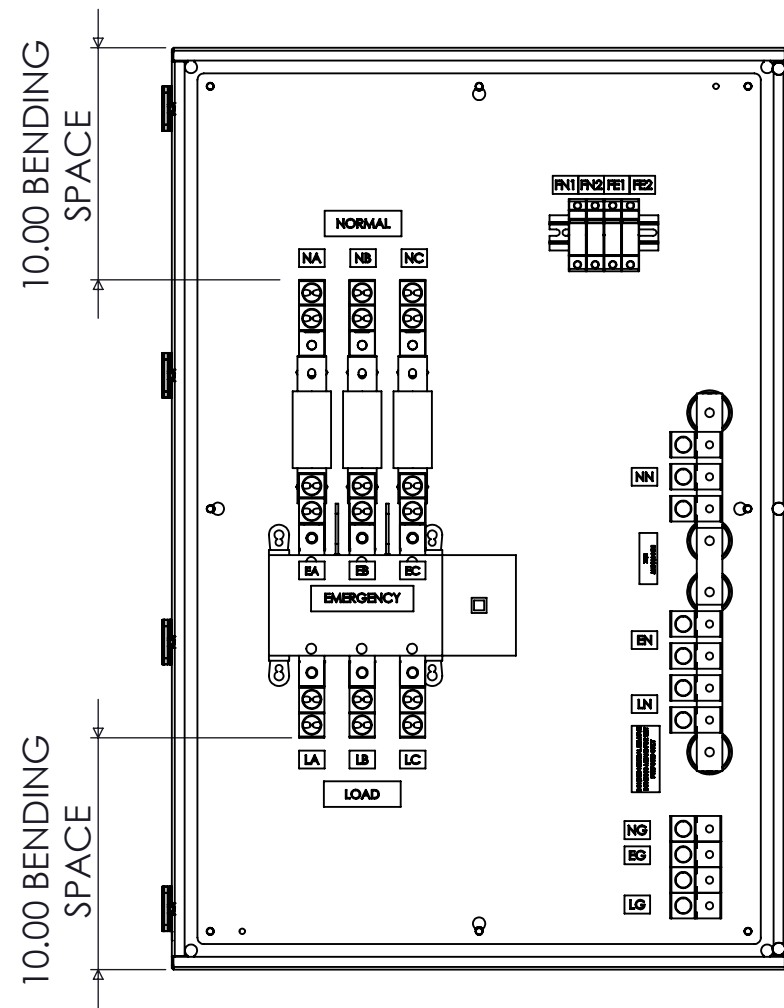

NOTE: FUSES PROVIDED IF PURCHASED
208-240VAC : FRN-R-200
480VAC : LPJ-200SP



9900 TWIN LAKES PARKWAY
CHARLOTTE, NC 28269
704-596-5617
PSICONTROLSOLUTIONS.COM

200A SE-RATED 3-POLE NEMA 4X MANUAL TRANSFER SWITCH

REV	DESCRIPTION	DATE	DRAWN	C. JUNG	
0	ORIGINAL RELEASE	9/15/17	CHECKED		
1	FUSES MOVED	10/19/21	SUP. NO		DRAWING TYPE
2	HARD BUS ADDED	02/07/22	SUP. BY NO		OUTLINE
			PANEL NO		DRAWING NUMBER
			BUL. NO		STS200N4XSE3
			GROUP NO		
			ORDER NO		