

SPECIFICATIONS

MAX VOLTAGE - 600VAC 3 ϕ
 RATED CURRENT - 2000 A
 ENCLOSURE RATING - NEMA 4X
 TYPE 316 STAINLESS STEEL
 REF. ES100145NF
 DURABILITY - 3000 CYCLES
 EST SHIPPING WEIGHT - 850LBS

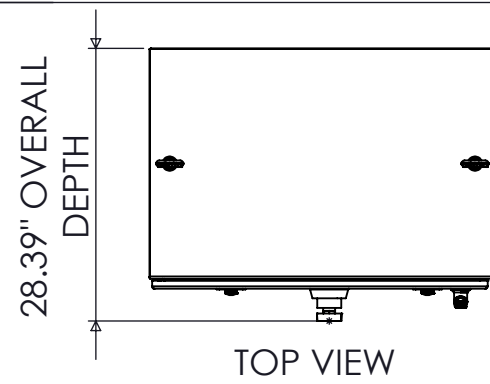

TOP VIEW

36" ENCLOSURE WIDTH

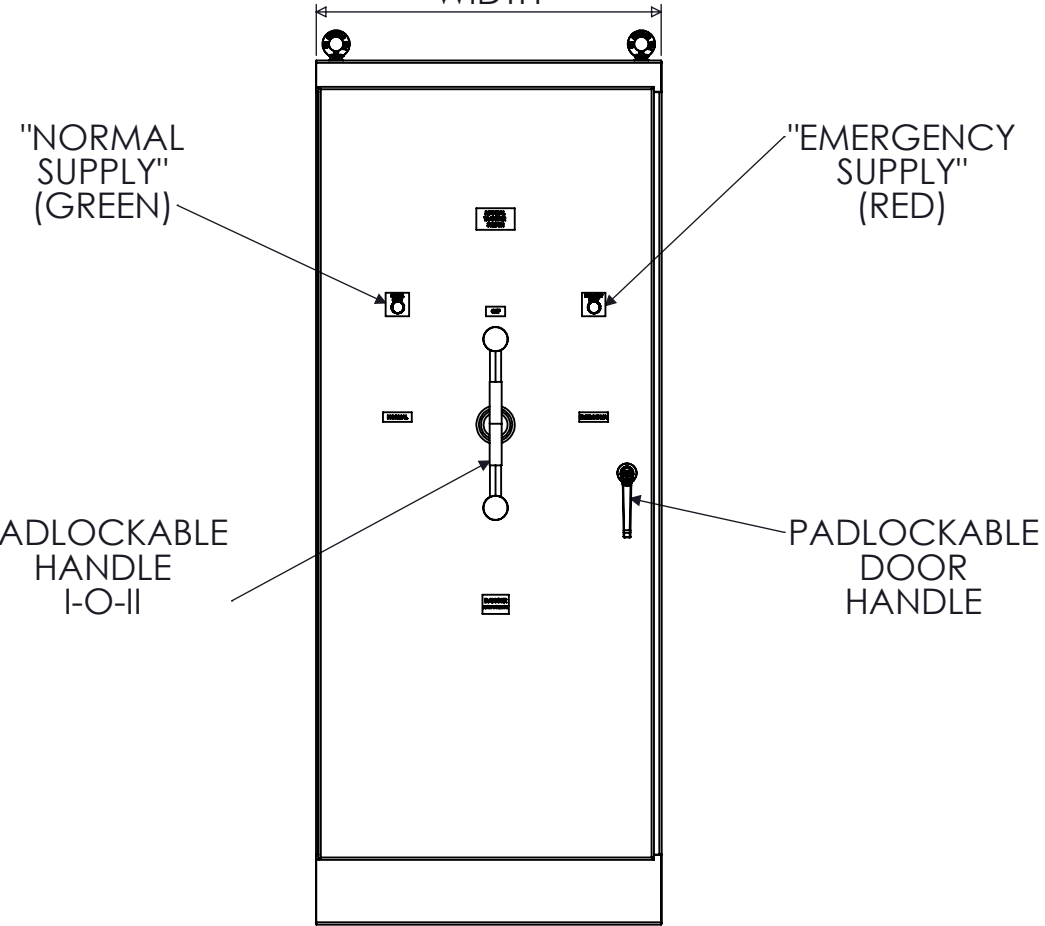

FRONT VIEW

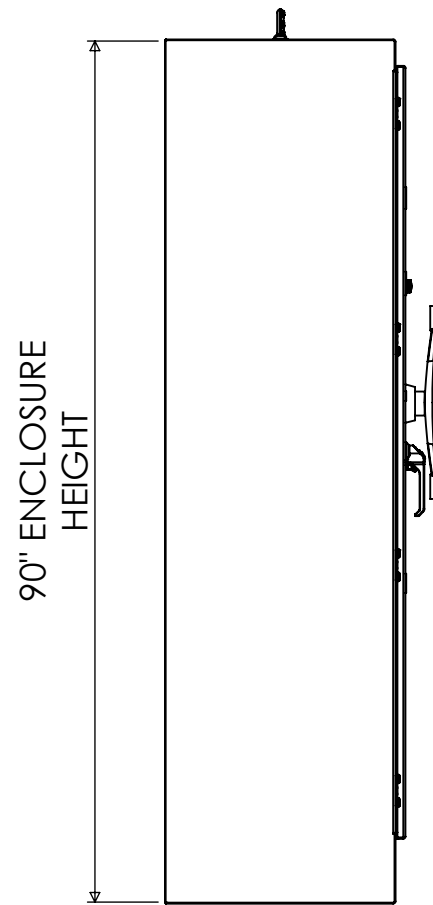

SIDE VIEW

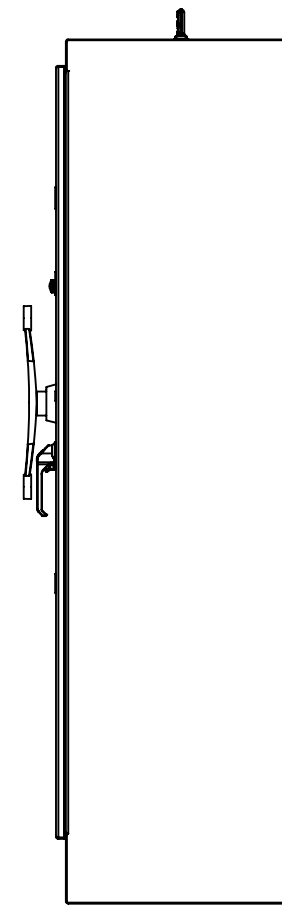

SIDE VIEW

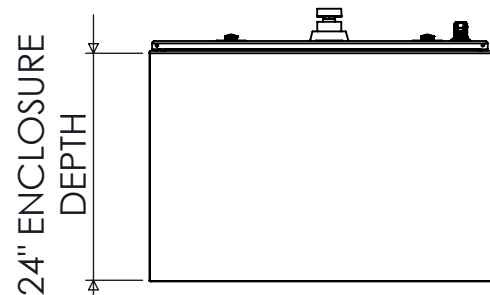

BOTTOM VIEW

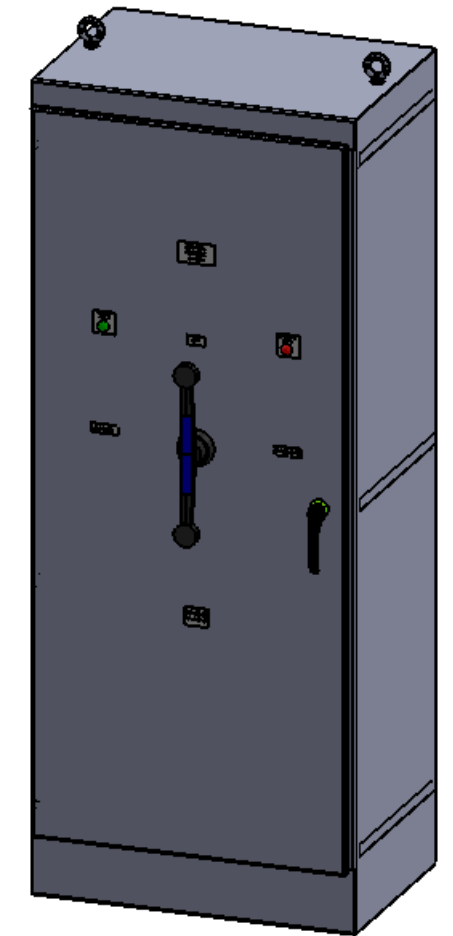

DIMETRIC VIEW

2000A NON-FUSED 3-POLE NEMA 4X MANUAL TRANSFER SWITCH

REV	DESCRIPTION	DATE	DRAWN	S.RICHARDSON	CHECKED
0	ORIGINAL RELEASE	2/25/14			
				SUP. NO	DRAWING TYPE
				SUP. BY NO	DIMENSIONAL
				PANEL NO	DRAWING NUMBER
				BUL. NO	STS2000N4XNF3
				GROUP NO	
				ORDER NO	



9900 TWIN LAKES PARKWAY
 CHARLOTTE, NC 28269
 704-596-5617
 PSICONTROLSOLUTIONS.COM

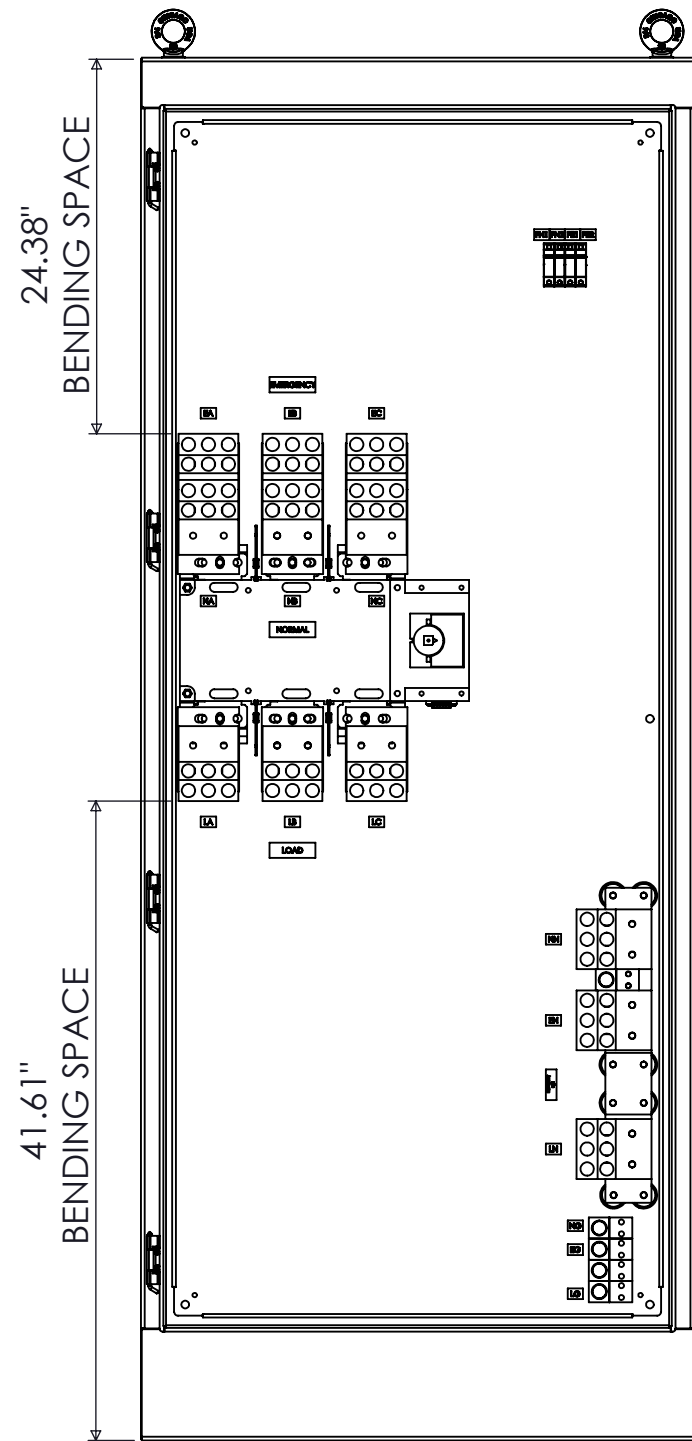

FRONT VIEW
DOOR REMOVED

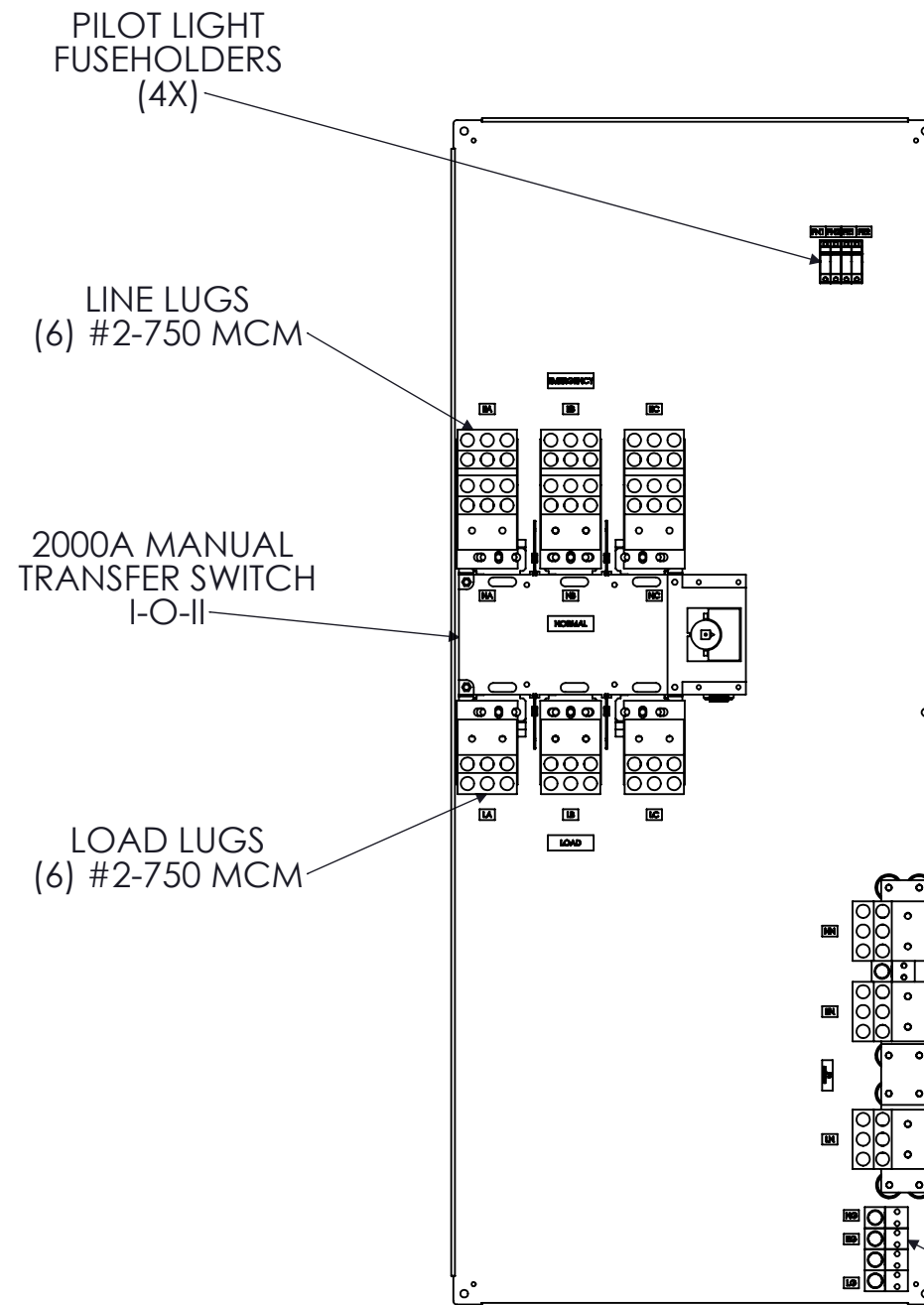

FRONT VIEW
ENCLOSURE REMOVED

"EMERGENCY"
CONNECTIONS
(REAR)

"NORMAL"
CONNECTIONS
(FRONT)

NEUTRAL LUGS
(6) #2-750 MCM

NEUTRAL
DISCONNECTING
MEANS

GROUND LUGS
(1) #2-750 MCM

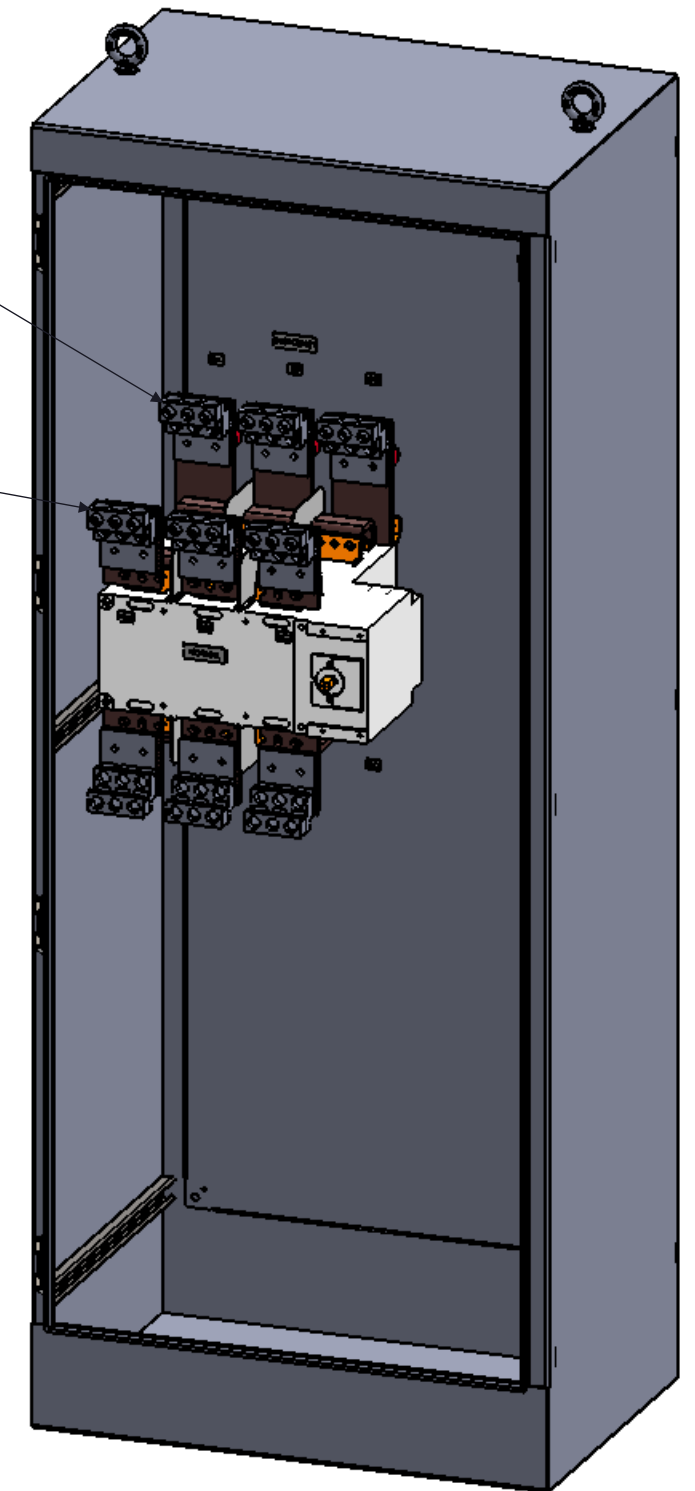

DIMETRIC VIEW
DOOR REMOVED

2000A NON-FUSED 3-POLE NEMA 4X MANUAL TRANSFER SWITCH

REV	DESCRIPTION	DATE	DRAWN	S.RICHARDSON	CHECKED
0	ORIGINAL RELEASE	2/25/14			
			SUP. NO		
			SUP. BY NO		
			PANEL NO		
			BUL. NO		
			GROUP NO		
			ORDER NO		

DRAWING TYPE
OUTLINE

DRAWING NUMBER
STS2000N4XNF3