

SPECIFICATIONS

MAX VOLTAGE - 600VAC 3 ϕ
 RATED CURRENT - 1600 A
 IEC RATED ONLY - NO UL LISTING
 ENCLOSURE RATING - NEMA 3R
 REF. ES100145BF
 DURABILITY - 4000 CYCLES
 EST SHIPPING WEIGHT - 850LBS

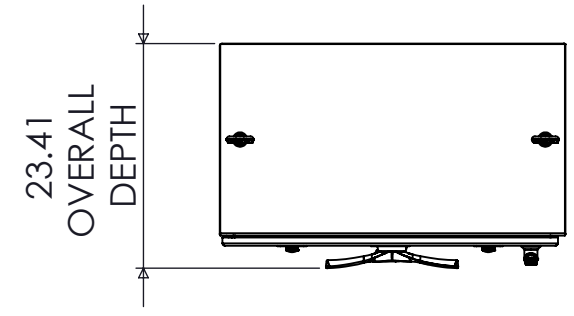

TOP VIEW
36.00
ENCLOSURE WIDTH

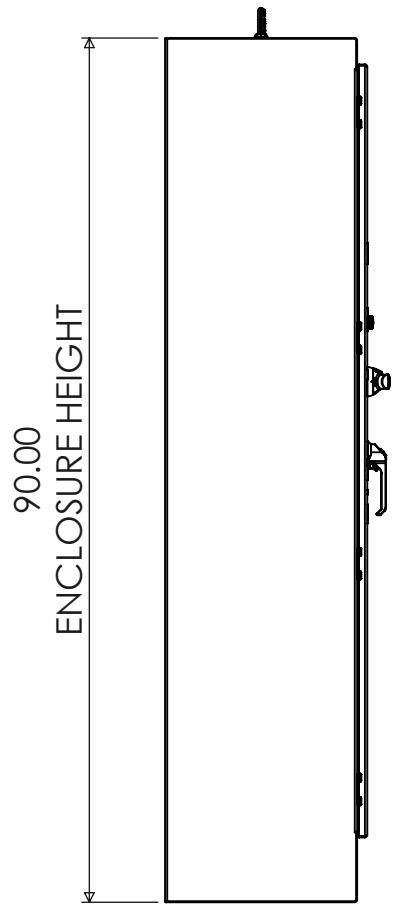

SIDE VIEW

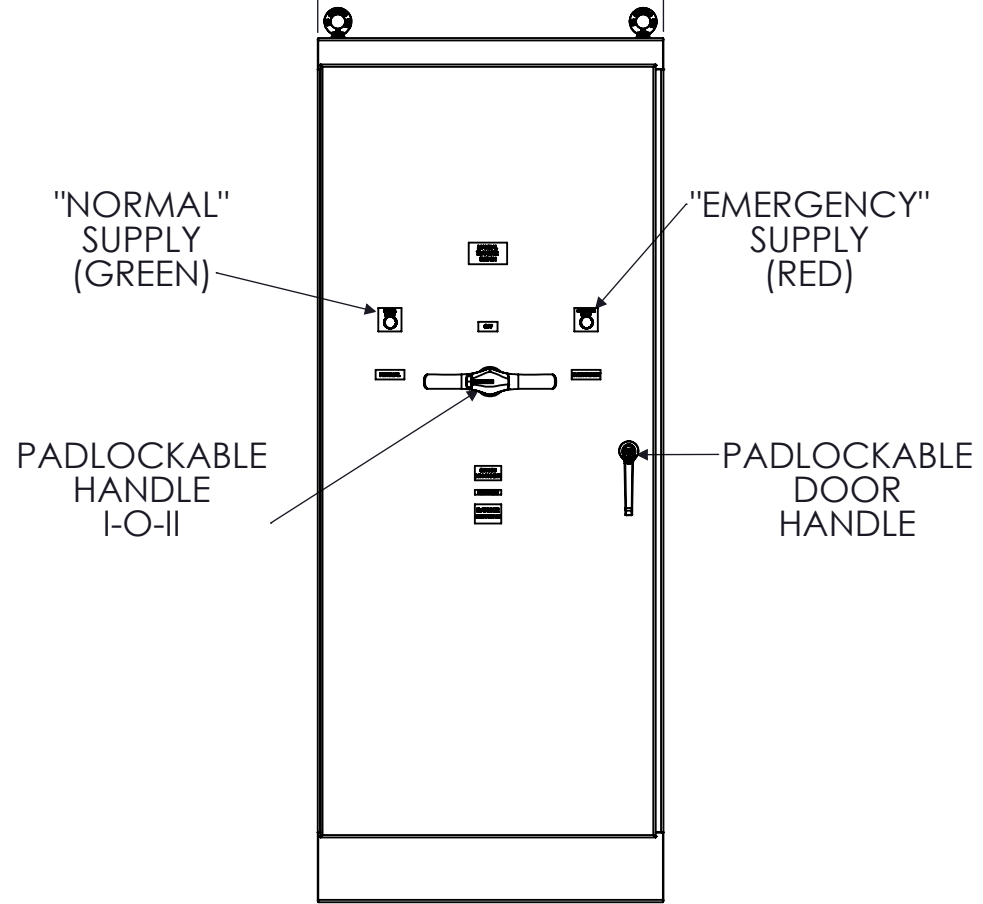

FRONT VIEW

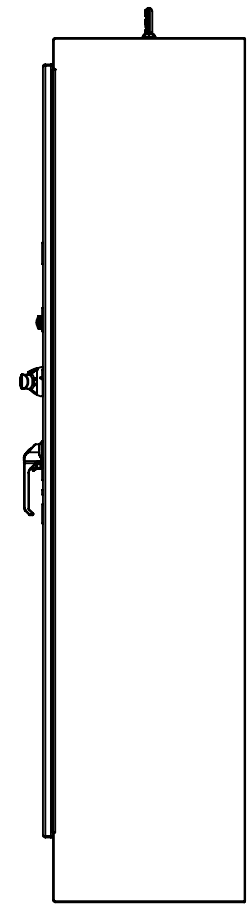

SIDE VIEW

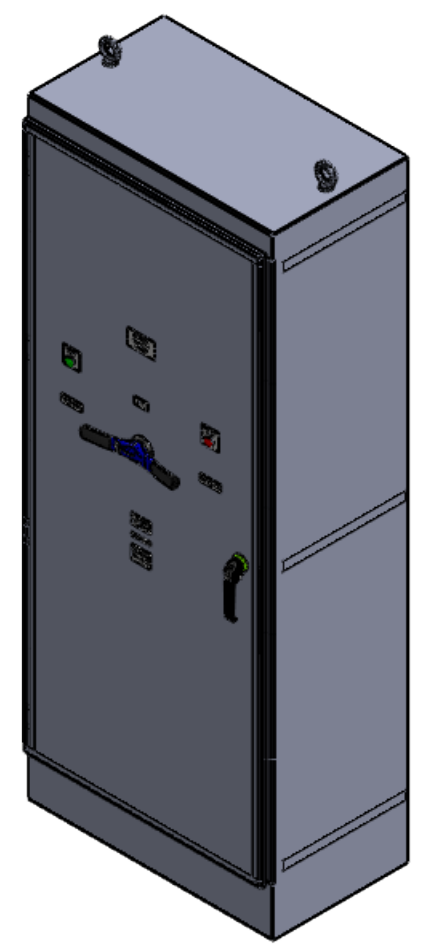

DIMETRIC VIEW

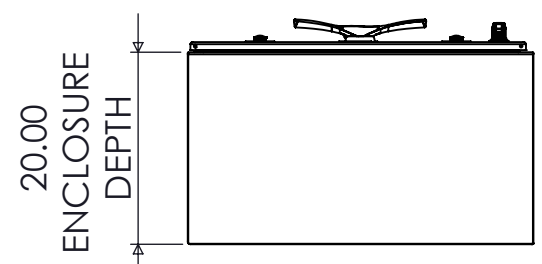

BOTTOM VIEW

 9900 TWIN LAKES PARKWAY
 CHARLOTTE, NC 28269
 704-596-5617
 PSICONTROLSOLUTIONS.COM

| 1600A FUSIBLE 3-POLE NEMA 3R MANUAL TRANSFER SWITCH | | | | |
|---|------------------|--------|------------|----------------|
| REV | DESCRIPTION | DATE | DRAWN | S.RICHARDSON |
| 0 | ORIGINAL RELEASE | 2/5/14 | CHECKED | |
| | | | SUP. NO | DRAWING TYPE |
| | | | SUP. BY NO | DIMENSIONAL |
| | | | PANEL NO | DRAWING NUMBER |
| | | | BUIL. NO | STS1600N3RBF3 |
| | | | GROUP NO | |
| | | | ORDER NO | |

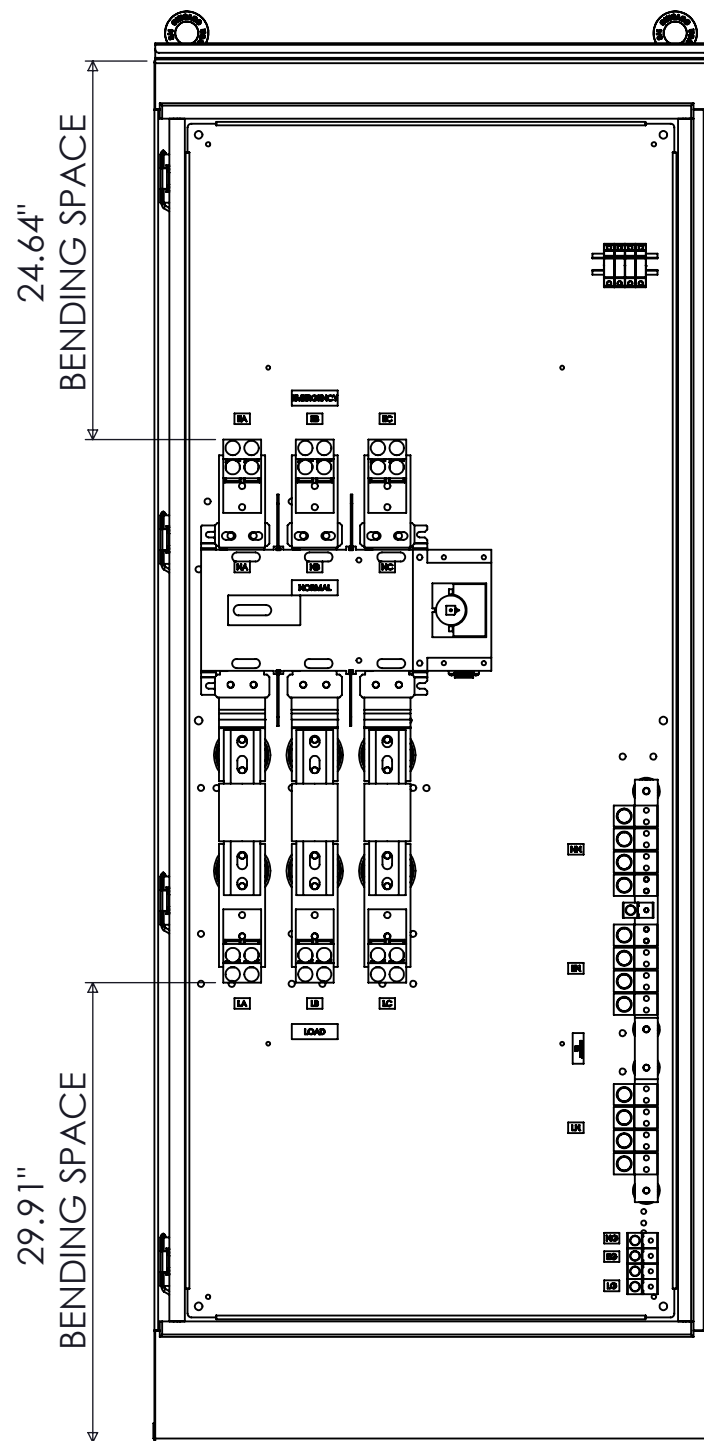

FRONT VIEW
DOOR REMOVED

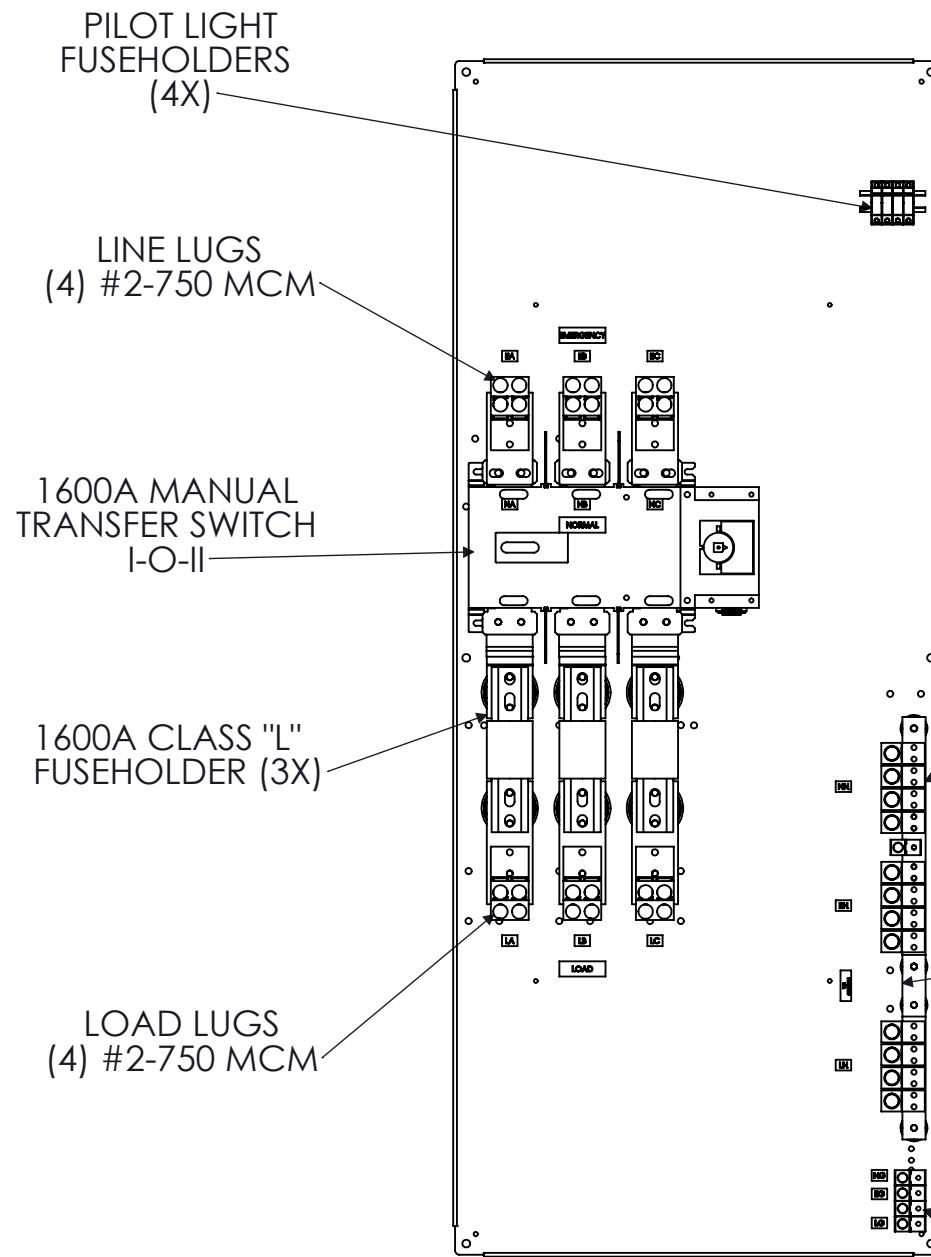

FRONT VIEW
ENCLOSURE REMOVED

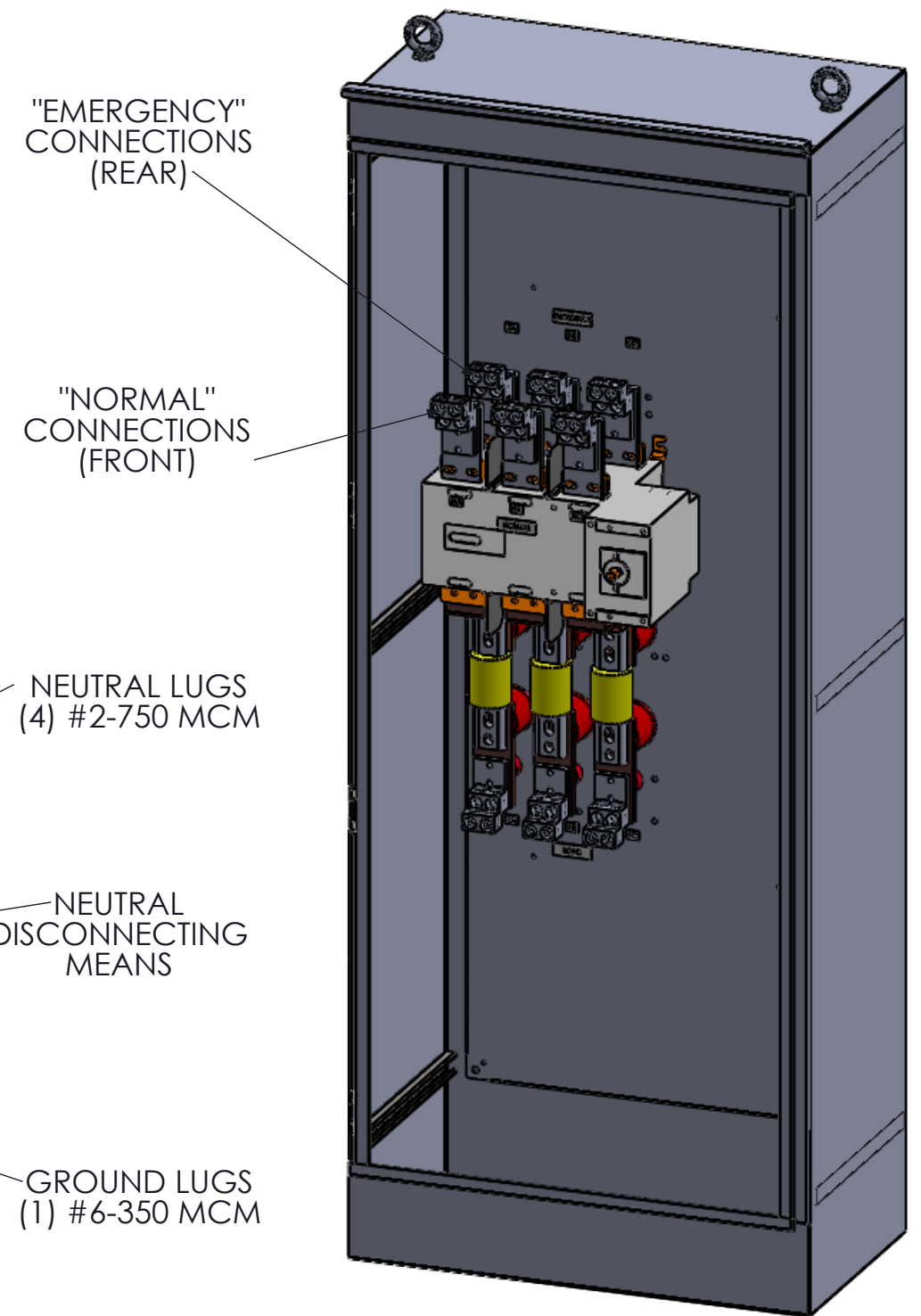

DIMETRIC VIEW
DOOR REMOVED

NOTE: FUSES PROVIDED IF PURCHASED
208-600VAC : KRP-C-1600SP

 9900 TWIN LAKES PARKWAY
CHARLOTTE, NC 28269
704-596-5617
PSICONTROLSOLUTIONS.COM

1600A FUSIBLE 3-POLE NEMA 3R MANUAL TRANSFER SWITCH

| REV | DESCRIPTION | DATE | DRAWN | S.RICHARDSON | |
|-----|------------------|--------|------------|--------------|----------------|
| 0 | ORIGINAL RELEASE | 2/5/14 | CHECKED | | |
| | | | SUP. NO | | DRAWING TYPE |
| | | | SUP. BY NO | | OUTLINE |
| | | | PANEL NO | | DRAWING NUMBER |
| | | | BUL. NO | | STS1600N3RBF3 |
| | | | GROUP NO | | |
| | | | ORDER NO | | |