

SPECIFICATIONS

MAX VOLTAGE - 600VAC 3 ϕ
 RATED CURRENT - 100 A
 STANDARDS - UL508A
 ENCLOSURE RATING - NEMA 4X
 TYPE 316 STAINLESS STEEL
 REF. ES100145BF
 DURABILITY - 6050 CYCLES
 EST SHIPPING WEIGHT - 135LBS

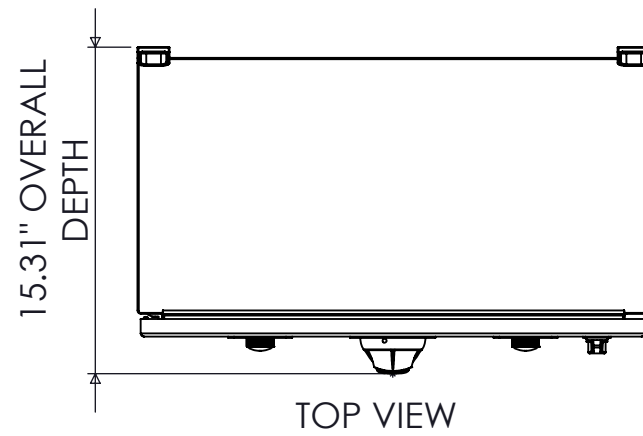

TOP VIEW

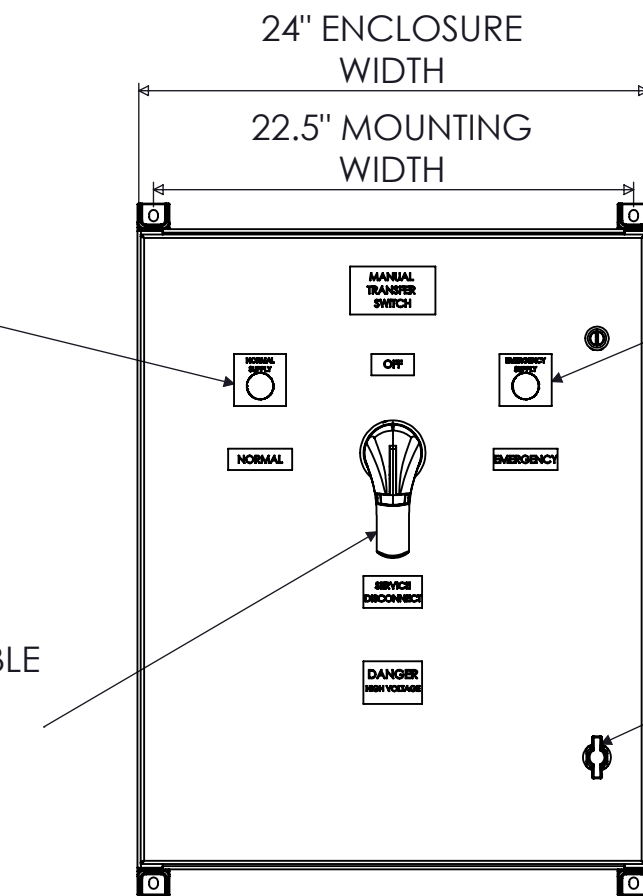

FRONT VIEW

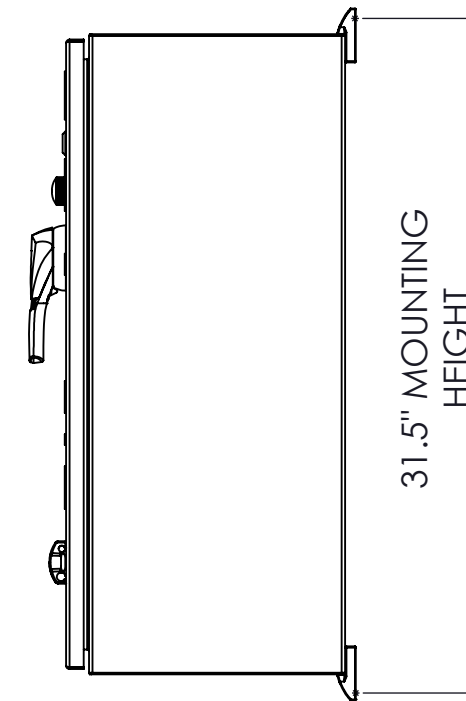

SIDE VIEW

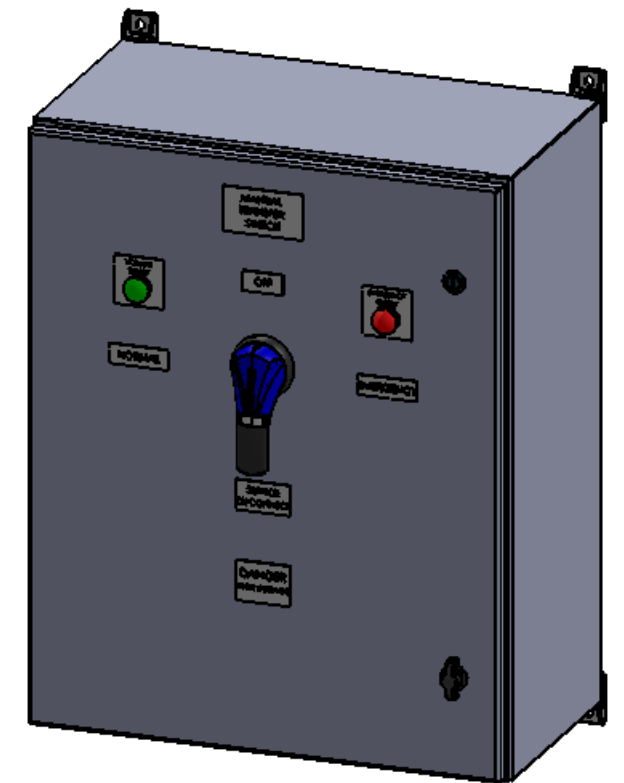

DIMETRIC VIEW

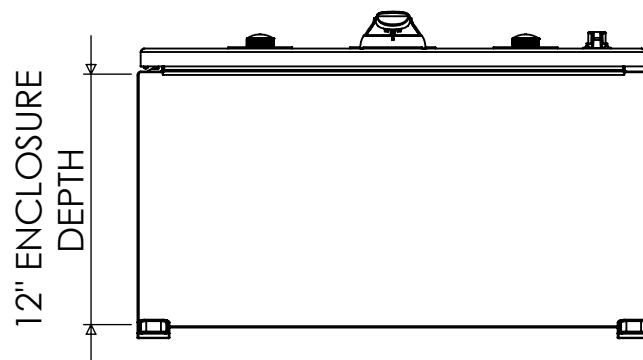

BOTTOM VIEW

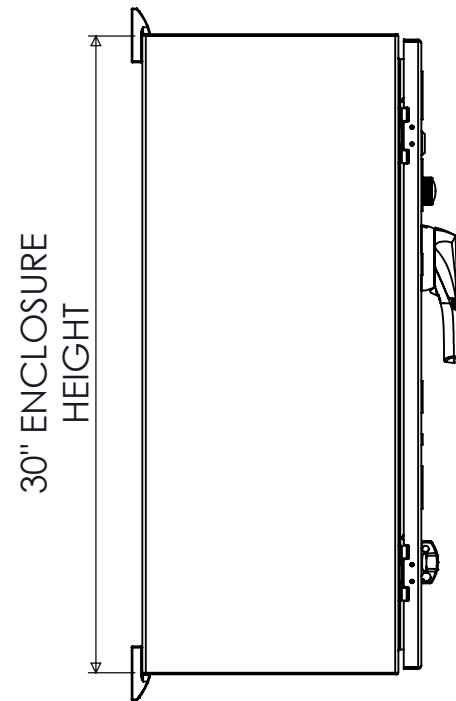

SIDE VIEW

30" ENCLOSURE HEIGHT

12" ENCLOSURE DEPTH

24" ENCLOSURE WIDTH
 22.5" MOUNTING WIDTH

31.5" MOUNTING HEIGHT

100A FUSIBLE 3-POLE NEMA 4X MANUAL TRANSFER SWITCH

REV	DESCRIPTION	DATE	DRAWN	S.RICHARDSON
0	ORIGINAL RELEASE	12/7/13	CHECKED	
			SUP. NO	DRAWING TYPE
			SUP. BY NO	DIMENSIONAL
			PANEL NO	DRAWING NUMBER
			BUIL. NO	STS100N4XBF3
			GROUP NO	
			ORDER NO	



9900 TWIN LAKES PARKWAY
 CHARLOTTE, NC 28269
 704-596-5617
 PSICONTROLSOLUTIONS.COM

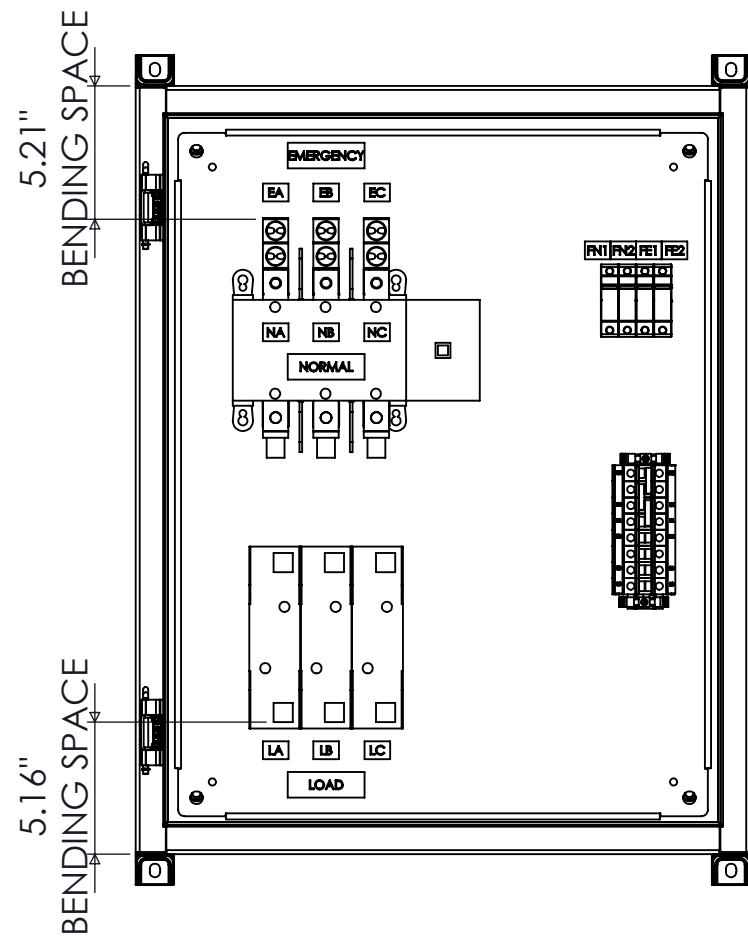

FRONT VIEW
DOOR REMOVED

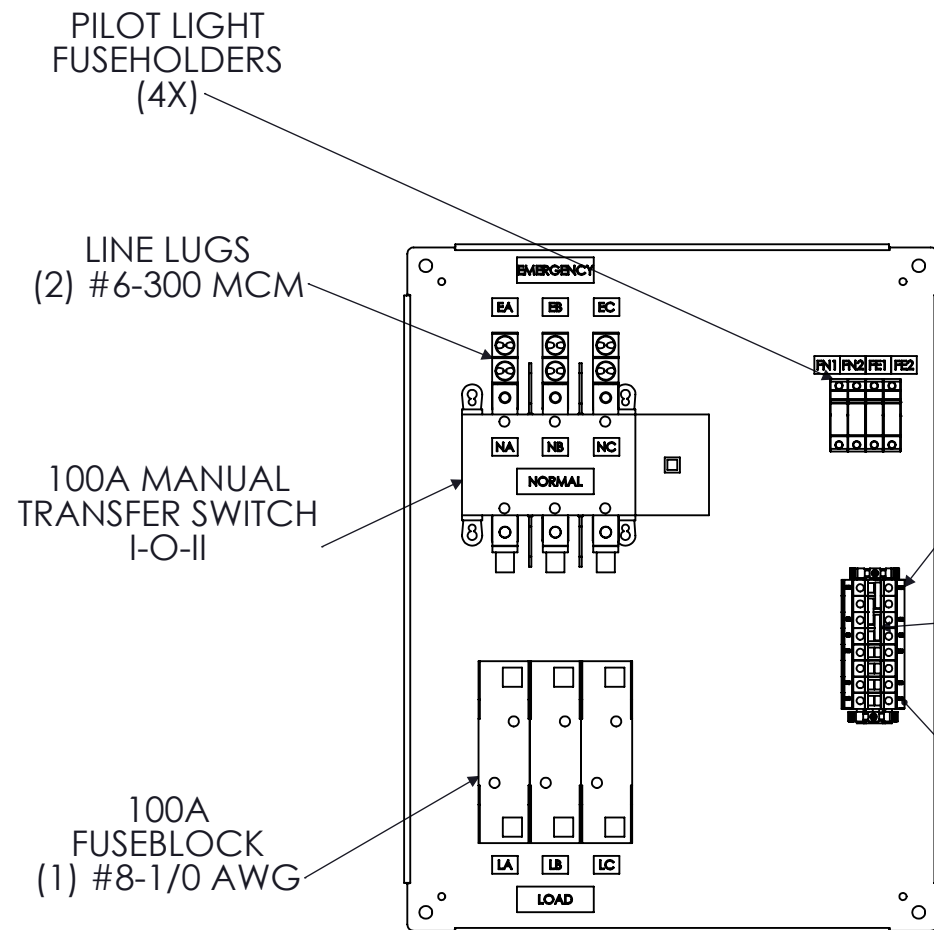

FRONT VIEW
ENCLOSURE REMOVED

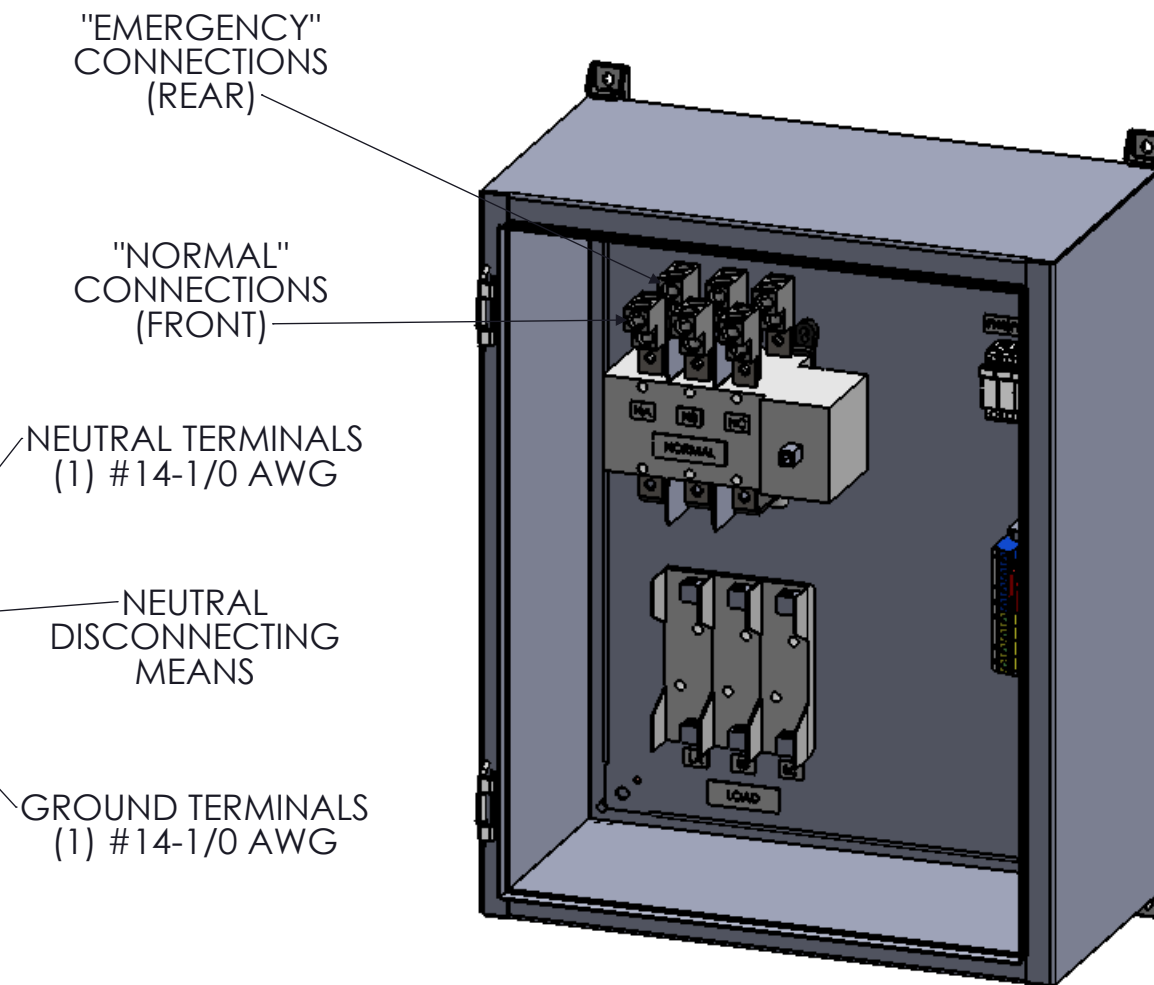

DIMETRIC VIEW
DOOR REMOVED

NOTE: FUSES PROVIDED IF PURCHASED
 208-240VAC : FRN-R-100
 480-600VAC : LPJ-100SP

 9900 TWIN LAKES PARKWAY
 CHARLOTTE, NC 28269
 704-596-5617
 PSICONTROLSOLUTIONS.COM

100A FUSIBLE 3-POLE NEMA 4X MANUAL TRANSFER SWITCH				
REV	DESCRIPTION	DATE	DRAWN	S.RICHARDSON
0	ORIGINAL RELEASE	12/7/13	CHECKED	
			SUP. NO	
			SUP. BY NO	
			PANEL NO	
			BUL. NO	
			GROUP NO	
			ORDER NO	

DRAWING TYPE	OUTLINE
DRAWING NUMBER	STS100N4XBF3