

TOP VIEW

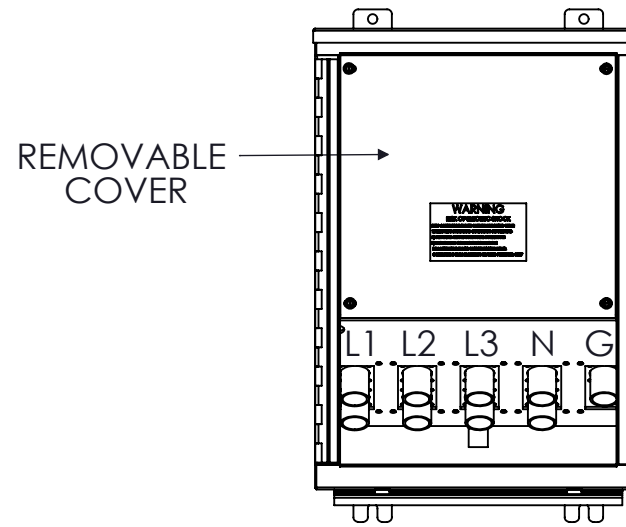

FRONT VIEW
DOOR REMOVED

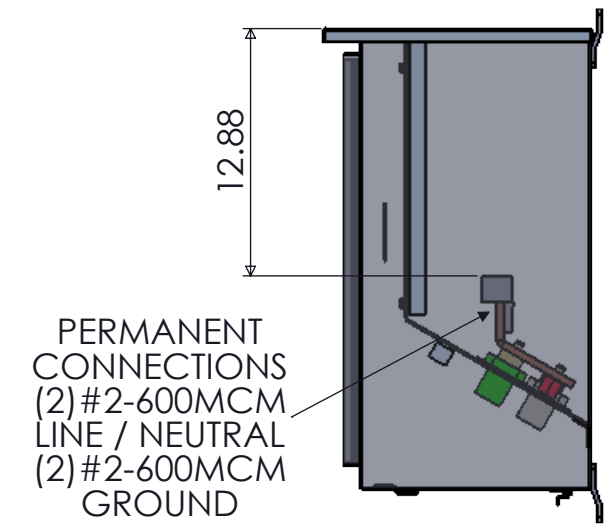

PERMANENT CONNECTIONS
(2) #2-600MCM
LINE / NEUTRAL
(2) #2-600MCM
GROUND

SIDE VIEW
INTERIOR

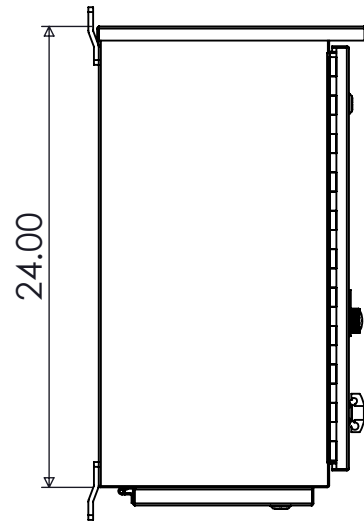

SIDE VIEW

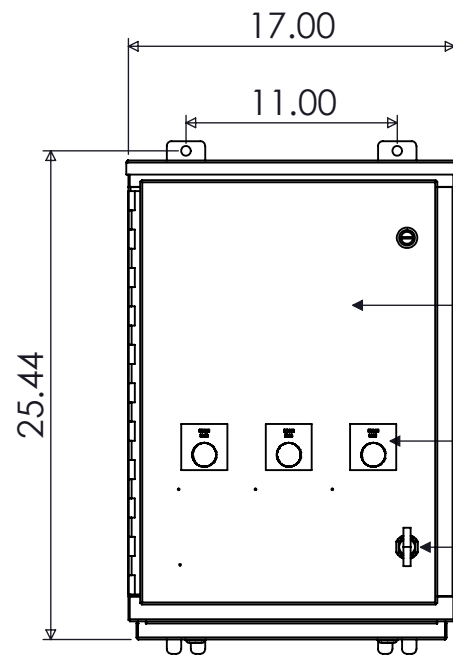

FRONT VIEW

PADLOCKABLE
FRONT ACCESS
DOOR

PHASE INDICATION
LIGHTS (3X)

PADLOCKABLE
WINGKNOB
LATCH

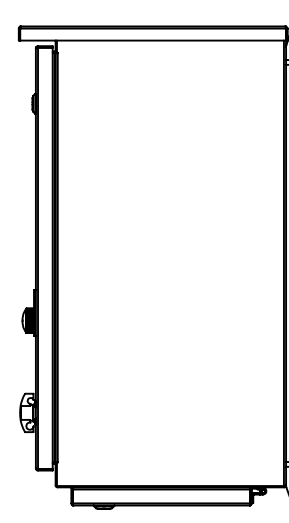

SIDE VIEW

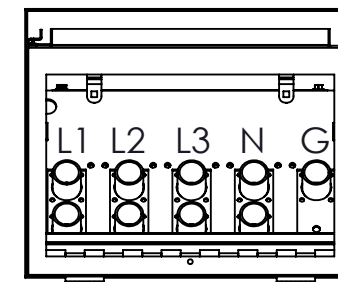

BOTTOM VIEW
DOOR REMOVED

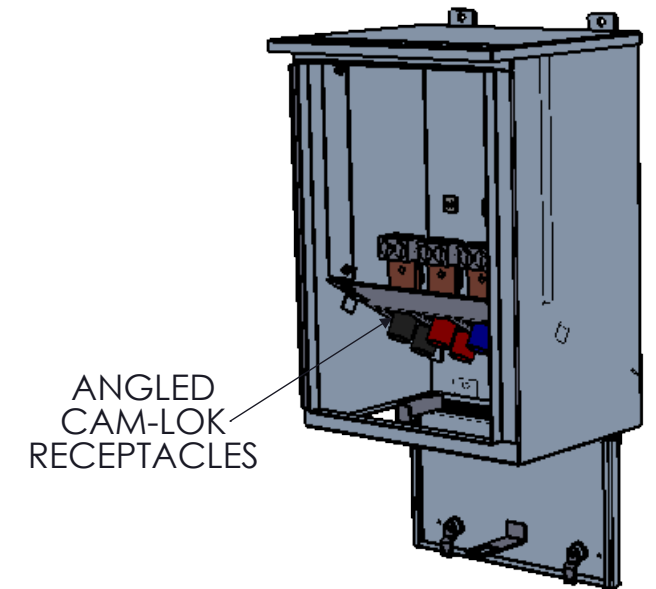

ANGLED
CAM-LOK
RECEPTACLES

TRIMETRIC VIEW
INTERIOR

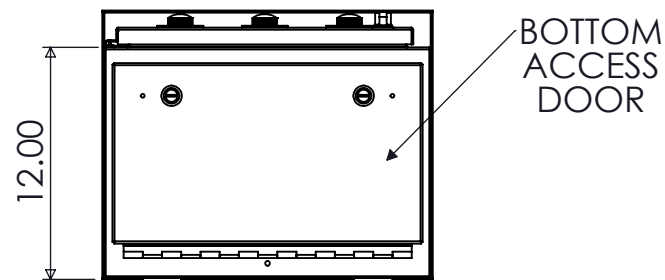

BOTTOM VIEW

BOTTOM
ACCESS
DOOR

NOTES

1. ENCLOSURE RATED NEMA 3R
2. TYPE 316 STAINLESS STEEL AVAILABLE
3. 3Φ, 4-WIRE SHOWN. ALTERNATE CONFIGURATIONS AVAILABLE
4. MAX VOLTAGE - 600VAC
5. STANDARDS - UL508A

RECEPTACLE COLOR SCHEME

	L1	L2	L3	N	GND
240V	BLK	RED	BLU	WHT	GRN
480V	BRN	ORG	YEL	WHT	GRN
600V	BLK	BLK	BLK	WHT	GRN

800A, NEMA 3R GENERATOR TAP BOX

REV	DESCRIPTION	DATE	DRAWN	JG
0	ORIGINAL RELEASE	10/15/15	CHECKED	
1	REMOVED SIDE VENTS	12/5/17	SUP. NO	
			SUP. BY NO	
			PANEL NO	
			BUL. NO	
			GROUP NO	
			ORDER NO	

DRAWING TYPE
DIMENSIONAL

DRAWING NUMBER
PL800GTBSM



9900 TWIN LAKES PARKWAY
CHARLOTTE, NC 28269
704-596-5617
PSICONTROLSOLUTIONS.COM