

SPECIFICATIONS

MAX VOLTAGE - 600VAC 3Φ
 RATED CURRENT - 60A
 STANDARDS - UL508A
 ENCLOSURE RATING - NEMA 4
 REF EST11NFD3
 ENDURANCE - 10,000 CYCLES
 EST. SHIPPING WEIGHT - 50LBS

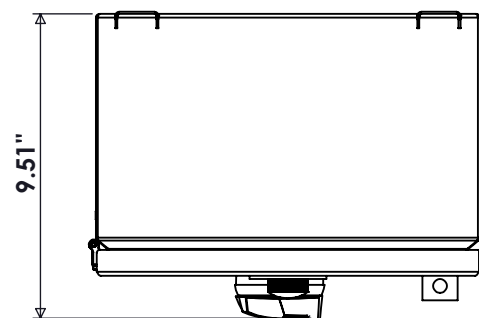

TOP VIEW

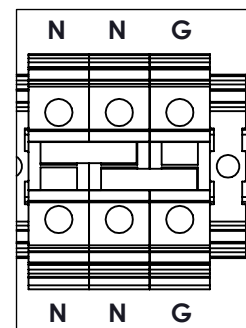

DETAIL A
 SCALE 1 : 2

CONNECTIONS

L1/L2/L3 - #14-1 AWG
 T1/T2/T3 - #14-1 AWG
 N/G - #14-1/0 AWG

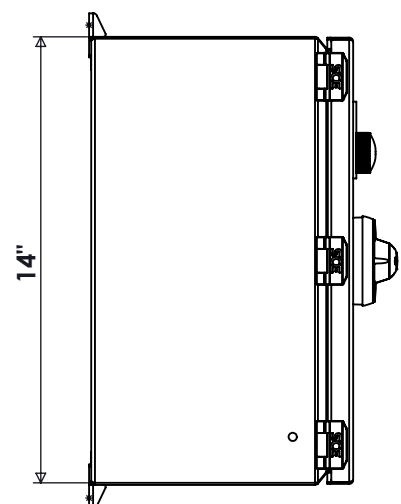

SIDE VIEW

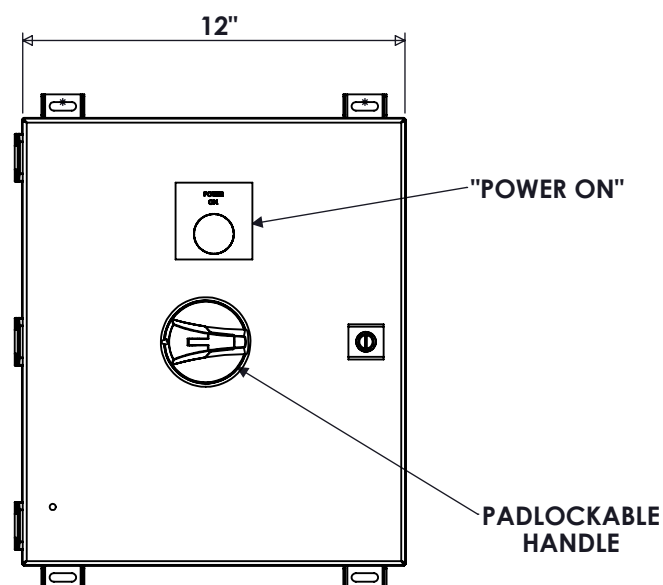

FRONT VIEW

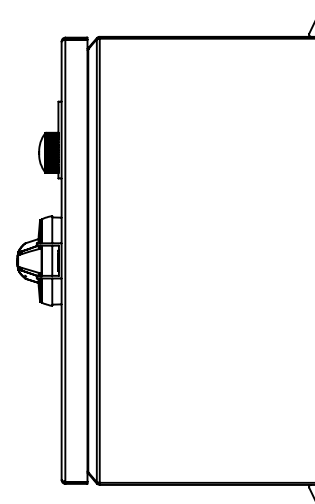

SIDE VIEW

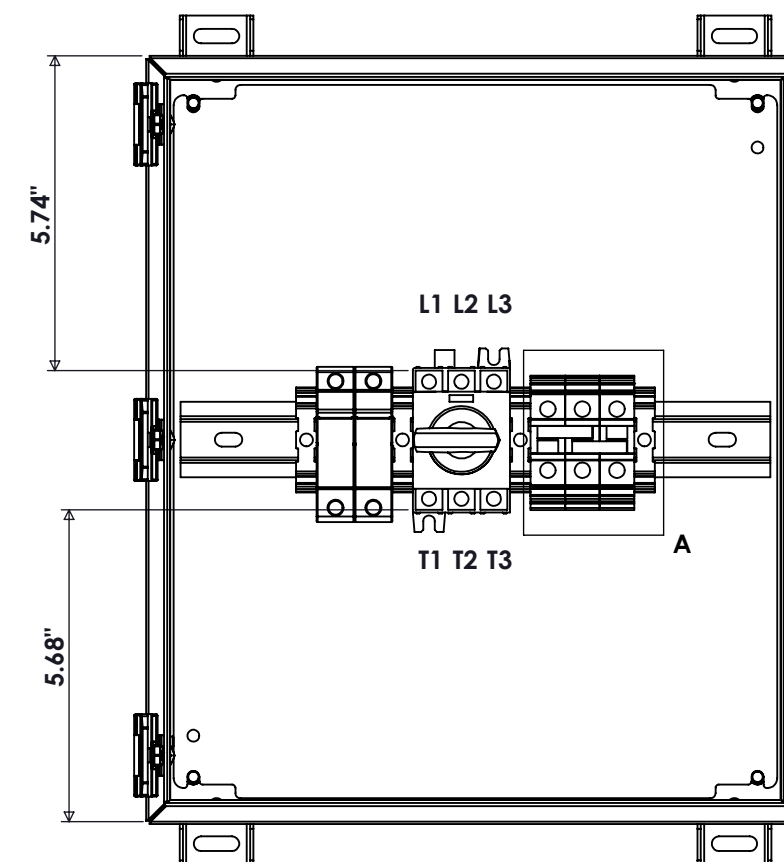

FRONT VIEW
 DOOR REMOVED

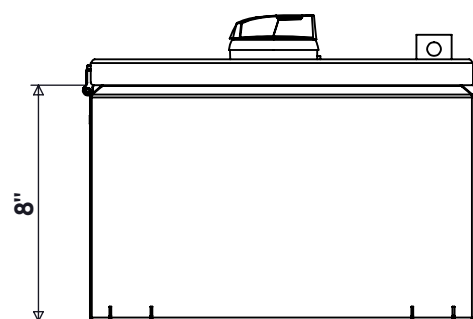

BOTTOM VIEW

NOTES

1: NEUTRAL KIT ONLY PRESENT IF PURCHASED



9900 TWIN LAKES PARKWAY
 CHARLOTTE, NC 28269
 704-596-5617
 PSICONTROLSOLUTIONS.COM

60A ENCLOSED, NONFUSED DISCONNECT NEMA 4			
REV	DESCRIPTION	DATE	DRAWN S.RICHARDSON
0	ORIGINAL RELEASE	11/14/16	CHECKED
			SUP. NO
			SUP. BY NO
			PANEL NO
			BUL. NO
			GROUP NO
			ORDER NO
			DRAWING TYPE
			DIMENSIONAL
			DRAWING NUMBER
			NFD60N4